

IKA

designed for scientists

EN



Innovative laboratory solutions for your research
PRODUCT OVERVIEW



IKA – YOUR RELIABLE LABORATORY PARTNER

/// Elevate your lab experience

Welcome to the world of IKA, where reliability meets innovation. IKA is known for manufacturing laboratory and analytical instruments of the highest quality and is your reliable partner in scientific research.

But our commitment does not end with the production of top-quality products. IKA goes above and beyond, offering a wide range of services worldwide - be it repair, maintenance, on-site installation, calibration, application support or device qualification.

Would you like to be informed even faster about innovations and news for your laboratory? Then subscribe to our newsletter.



Stay up to date:
www.ika.com/newsletter

[Bioprocessing](#) 10 Bioreactors

[Electrochemistry](#) 20 ElectraSyn 2.0 26 Screening System

[Flow Chemistry](#) 28 FLOW System

[Mixing](#) 30 TWISTER 34 Magnetic Stirrers 46 Overhead Stirrers 58 Thermoshakers 62 Shakers

[Crushing](#) 74 Dispersers 82 Mills 88 Single-Use Crushing / IVD

[Measuring viscosity](#) 94 Measuring Stirrers 96 Viscometers

[Vacuum technology](#) 104 Vacuum Pumps 107 Vacuum Controller

[Heating/Cooling/Tempering](#) 108 Temperature Control 118 Dry Block Heater 121 Hot Plates 122 Heating Baths

[Tempering Chambers](#) 124 Incubators / Incubator Shakers 126 Drying Ovens

[Separation](#) 128 Rotary Evaporators 134 Centrifuges

[Liquid Handling](#) 136 Pipettes

[Reactor Systems](#) 142 Synthesis Reactors 145 High Viscosity Reactors

[Controlling/Measuring](#) 150 labworldsoft® 6 151 CalWin 6040

[Calorimetry](#) 152 Calorimeters 155 Decomposition Systems

[Accessories](#) 160 Mechanical & Electronic Accessories

[Complete Solutions](#) 162 Packages

/// CALIBRATION SERVICES

Ensuring quality and reproducibility: We calibrate all your laboratory devices and document measurement and reference values under specially defined conditions.

If you would like to have your laboratory or analytical device (e.g. ROTAVISC) calibrated regularly, you can benefit from our combined calibration and maintenance agreement. On request, we will provide you with a quotation for regular or even one-off testing adapted to your individual requirements.

Factory calibration certificates (ISO calibration)

You will receive a factory calibration certificate according to DIN EN ISO 9001 for your new IKA laboratory & analytical device. The calibration will be performed by our service department before delivery or at your site. The certificate includes up to two calibration parameters at up to two test points as proof of the main function of the device. Typical calibration parameters for IKA devices are temperature and speed.

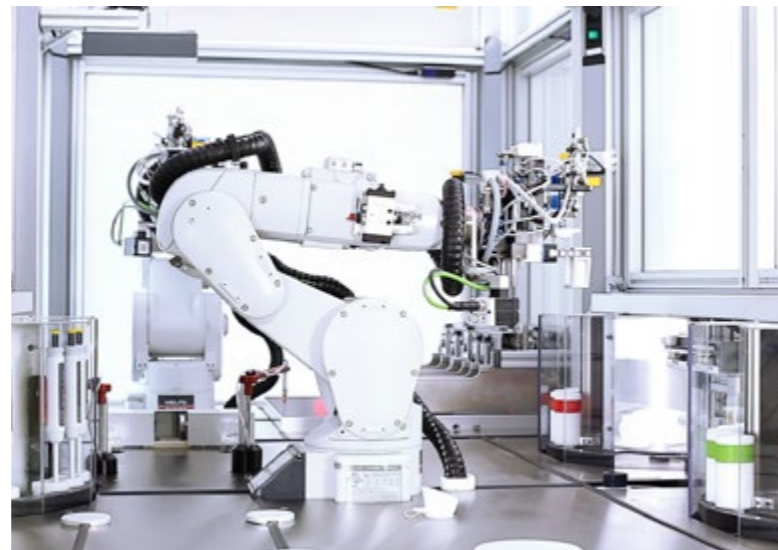

General certificates (2.1, 2.2 or 3.1)

For accessories, surface certificates (according to 3.1) or material certificates (according to 2.2 or 2.1) can be issued if required (with additional effort and costs if necessary).

Please note that acceptance test certificates according to DIN EN 10204 - 3.1 must be ordered together with the respective devices or accessories. In most cases, it is not possible to issue them at a later date. This also applies to FDA or GMP certificates, which you require for some of our products and accessories. Please contact us in this regard before ordering. We will check for you whether the required certificates are available for your order.



/// QUALIFICATION OF NEW DEVICES

For your application it is essential that the laboratory equipment used meets your technical specification! We prove that this is the case at IKA. In the course of a qualification we use visual, safety and functional test certificates.

Documents for qualification

The set of documents contains everything you need for your own internal qualification:

- › EU Declaration of Conformity
- › Factory certificate (2.1)
- › Factory calibration certificate according to DIN EN ISO 9001
- › Factory certificate of the devices or accessories
- › Proof or certificates of material (if available)

These documents are a supplement to the factory calibration certificates and verifications and are issued on a product-specific basis prior to delivery.

DQ/IQ/OQ/PQ documents

With these documents, we offer assistance for your own, customer-specific validation of individual devices or entire IKA complete solutions.

The product-specific documents are prepared individually according to your requirements. These product-specific documents consist of detailed descriptions of installation qualifications (IQ), functional tests (OQ) and process qualifications (PQ) to be performed based on the customer specification (DQ).

If you operate different devices as a functional unit, we support you in all application-related questions and prepare individual acceptance documentation.



Qualification implementation (IQ/OQ/PQ)

We also commission your new laboratory devices for you and check it personally using the IQ/OQ/PQ documents. In this way, we ensure that it meets your specific requirements. For this purpose, we develop an individual validation plan for you. On site, we prove that your laboratory device does exactly what it is supposed to do.

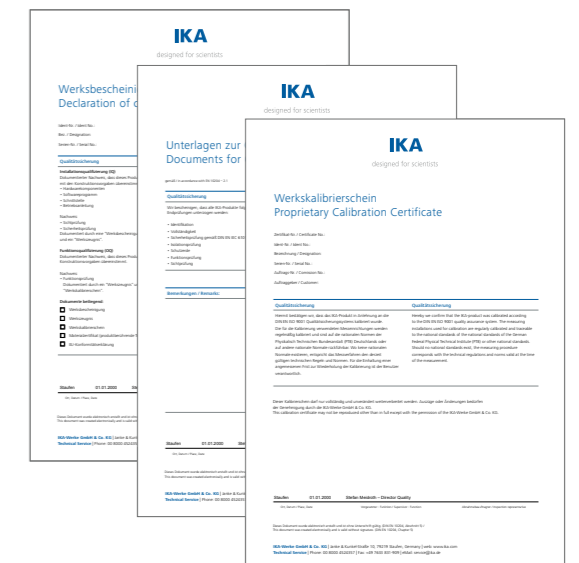

/// APPLICATION SUPPORT

You can test all of the laboratory equipment yourself at the IKA Application Center. Our experts will analyze your samples and work with you to decide how to optimize your application. Our Application Center shows the latest laboratory equipment over an area of 400 m².

Equipment tests

The Application Team provides support with customized testing of equipment and processes.

Sample analysis and application recommendation

We also process samples sent in to us and give you a report on the results with application recommendations within a period of two working days.

Customizing Center

If you can't find exactly what you are looking for, get in touch with the IKA Customizing Center. Our team will check how we can fulfill your product requirements using customized solutions. For further information and examples of implemented product change requests, please contact sales@ika.de.



/// WORLDWIDE SERVICE

Your decision to use a product from IKA is also a decision to opt for the excellent technical service provided by IKA in your region. Our team is at your disposal worldwide for service questions. Availability of replacement parts for your IKA laboratory equipment is guaranteed for 10 years.

Any questions? Our service team is at your personal disposal:
00 8000 4524357 (00 8000 IKAHELP)

IKA warranties

IKA offers generous free warranty extensions if you register your product at www.ika.com/register within 90 days after purchase. You can normally benefit from a year of additional services (2+1). With some equipment we even guarantee several years of warranty extensions:

- › Rotary evaporators and KS 4000 incubation shakers: warranty extension for three years (2+3).
- › Viscometers, ElectraSyn 2.0, RCT digital, C-MAG HS 7 control and the MICRO-/MINISTAR series: extension by a full eight years (2+8).
- › For pipettes and calorimeters: a one year warranty plus an additional year following registration (1 + 1).

The free warranty extension can be acquired in just a few clicks at www.ika.com/register.



Virtual Reality Demo

Our Virtual Reality trainings will help you increase productivity, reduce travel costs and gain insights into our products like never before! You can freely choose between various applications and meet our specialists for remote expert talks directly in the virtual world.



Book your experience now:
www.ika.com/vr-demo



/// AWARD-WINNING LABORATORY EQUIPMENT

Continuous innovative strength, design quality, global sense of responsibility or regional commitment – IKA receives awards for outstanding performance time and again. Entrepreneurial courage, dynamic processes and a willingness to communicate are the reasons for these successes. And they show us that commitment and perseverance always pay off!



iF Design Award 2023 for HABITAT

Our new bioreactor HABITAT research convinced the jury of the world's oldest independent design institution, iF International Forum Design GmbH. HABITAT proved that it is possible to work easily and pleasantly even with highly complex devices. As the first laboratory bioreactor with a lid stand, it saves users a lot of handling, ensures ergonomic working and a tidy laboratory. Its unique "Chaotic Mixing" mode enables faster and more efficient mixing. The consistently intuitive operation shortens the familiarization period.



Innovative strength and economic success

IKA continues to be honored for its innovative spirit. Since 2012, we've been recognized five times as one of the most innovative companies in Germany, which are awarded by the TOP 100 panel and mentor Ranga Yogeshwar. In 2015, IKA made it to second place in the class of companies with more than 250 employees. IKA was also shortlisted for the Innovation Award at ACHEMA 2018 in Frankfurt am Main with ElectraSyn 2.0, the pioneering product in electrochemistry. In addition, studies by the University of St. Gallen have placed our company in the world market leader index for years, which is reflected by the corresponding seal of WirtschaftsWoche. Once again, we are entitled to hold the corresponding seal in 2024.

Design strength and user-friendliness

Whether the iF Design Award, Red dot design award or the German Design Award: the fact that an appealing and user-friendly design plays a central role in product development for IKA is regularly honored.

In 2022, the TWISTER, the completely rethought mixing expert with patented design from IKA, received the Red dot award in the product design category. TWISTER thus joins the ranks of IKA's Red dot award-winning devices: the Tube Mill control batch mill, LR 1000 laboratory reactor, the shakers Roller and Trayster digital, the magnetic stirrer C-MAG HS 7 control and the global innovation ElectraSyn 2.0, a device for electrochemical synthesis.

In 2021, MATRIX Orbital Delta Plus received the German Design Award in the category "Excellent Product Design - Industry". In 2020, it was the new IKA PETTE fix and vario pipettes with their total of 18 different models, and in 2018 the IKA T 25 easy clean ULTRA-TURRAX® high-performance disperser. The iF Design Award was awarded not only to the HABITAT bioreactor in 2023, but also to the IKA PETTE (2020), KMO 3 and RCT digital magnetic stirrers and the MINISTAR 80 overhead stirrer (all 2017), as well as other devices.



Corporate responsibility



In 2023, IKA was once again nominated as part of the medium-sized company award for social responsibility from the German state of Baden-Württemberg (Lea-Mittelstandspreis). Of the numerous applicants, only five companies in each category received this prestigious nomination. In 2013, IKA was honored with first place for its extraordinary contribution with the HANDS FOR CHILDREN aid project. Also in 2013, the Oskar Patzelt Foundation awarded IKA the "Großer Preis des Mittelstandes": In the Baden-Württemberg state competition, IKA took first place in the industry category.

The time has come for new ergonomic and efficient solutions in the life science laboratory. A smarter way of working that can also be enjoyable under high pressure. That is why we have combined all the core competencies from more than a hundred years of IKA in a new generation of bioreactors. Here we set new standards in mixing, temperature control, automation, safety and design.

HABITAT RESEARCH /// The ergonomic bioreactor



▶ Watch HABITAT video



HABITAT research is the first laboratory bioreactor with a motor size that matches the volume. The handling is simple, the training time is short. As the first bioreactor with a lid stand, it ensures ergonomic working and a tidy laboratory. In combination with a circulator, e.g. HRC 2 lite, it is your fermenter, and if you connect light panels, your new photobioreactor.

LID STAND

The lid stand makes experiment preparation easier. The lid does not have to be put down and the motor and sensors are hooked onto the stand. This way, all connections are accessible and the sensors are protected. And everything together finds room in the autoclave.

CHAOTIC MIXING

In addition to the familiar stirrer control modes, there is the new innovative Chaotic Mode. Here, mixing follows the mathematical principle of chaotic-dynamic systems. The result is a

more homogeneous mixture. You can also choose between 3 different stirrer geometries: 6-blade disk stirrer, 3-blade segment stirrer and surface stirrer.

INDIVIDUAL PID HANDLING

With HABITAT research, you as the admin have PID handling in your own hands, giving you more leeway when scaling growth processes. But don't worry: if you change temperature values, the software simulates the consequences of the change for the processes for your safety.

HABITAT cell

Price on request
Ident. No. 0010007533



HABITAT cell cct

Price on request
Ident. No. 0010007573

HABITAT ferment

Price on request
Ident. No. 0010007543



HABITAT ferment cct

Price on request
Ident. No. 0010007585

HABITAT photo cell

Price on request
Ident. No. 0010007553

HABITAT photo ferment

Price on request
Ident. No. 0010007563

HABITAT photo cell cct

Price on request
Ident. No. 0010007595

HABITAT photo ferment cct

Price on request
Ident. No. 0010007605



TECHNICAL DATA

Speed range

HABITAT CELL / CCT

HABITAT PHOTO CELL / CCT

1 – 2200 rpm

Number of pump heads

4 (Acid, Base, Anti-Foam, Level)

Pump flow rate

1 – 270 ml/min

Gas flow rate

0.01 – 2 l/min

Number of mass flow controllers (MFC)

4 (Air, O₂, N₂, CO₂)

Control parameter

Stirrer, gas flush, liquid feed, off-gas analysis, temperature, pH, DO, foam, level (conductivity, CO₂, turbidity, light)

Interfaces

USB, PC connect, RS232, Ethernet, SU connect, circulator, ext. pump, ext. signal 4...20 mA

Dimensions (W x H x D)

224 x 624 x 405 mm

HABITAT FERMENT / CCT

HABITAT PHOTO FERMENT / CCT

1 – 2200 rpm

4 (Acid, Base, Anti-Foam, Level)

1 – 270 ml/min

0.01 – 20 l/min

4 (Air, O₂, N₂, CO₂)

Stirrer, gas flush, liquid feed, off-gas analysis, temperature, pH, DO, foam, level (conductivity, CO₂, turbidity, light)

USB, PC connect, RS232, Ethernet, SU connect, circulator, ext. pump, ext. signal 4...20 mA

224 x 624 x 405 mm

① HABITAT cell sw 0.5

Price on request
Ident. No. 0010007644

② HABITAT cell dw 0.5

Price on request
Ident. No. 0010007645



① HABITAT cell sw 1

Price on request
Ident. No. 0010007646

② HABITAT cell dw 1

Price on request
Ident. No. 0010007647



① HABITAT cell sw 2

Price on request
Ident. No. 0010007648

② HABITAT cell dw 2

Price on request
Ident. No. 0010007649



① HABITAT cell sw 5

Price on request
Ident. No. 0010007650

② HABITAT cell dw 5

Price on request
Ident. No. 0010007651



③ HABITAT cell dw 10

Price on request
Ident. No. 0010007652



TECHNICAL DATA

Vessel type	Single wall, borosilicate glass
Total volume	0.8 l 1.6 l 3 l 6.7 l
Working volume	0.25 – 0.5 l 0.3 – 1 l 0.6 – 2 l 1 – 5 l
Speed range	1 – 1400 rpm 1 – 2000 rpm 1 – 2200 rpm 1 – 1500 rpm
Temperature control	Heating sleeve, RT – 60 °C
pH sensor (resolution)	0 – 14 pH (0.01 pH)
DO sensor (resolution)	0 – 200 % (0.01 %)
Sparger type	Micro sparger, 5 µm
Stirrer type	3-blade segment stirrer
Material in contact with product	AISI 316L, borosilicate glass 3.3, silicone USP class VI

HABITAT CELL SW
0.5 | 1 | 2 | 5

Vessel type	Single wall, borosilicate glass
Total volume	0.8 l 1.6 l 3 l 6.7 l
Working volume	0.25 – 0.5 l 0.3 – 1 l 0.6 – 2 l 1 – 5 l
Speed range	1 – 1400 rpm 1 – 2000 rpm 1 – 2200 rpm 1 – 1500 rpm
Temperature control	Heating sleeve, RT – 60 °C
pH sensor (resolution)	0 – 14 pH (0.01 pH)
DO sensor (resolution)	0 – 200 % (0.01 %)
Sparger type	Micro sparger, 5 µm
Stirrer type	3-blade segment stirrer
Material in contact with product	AISI 316L, borosilicate glass 3.3, silicone USP class VI

HABITAT CELL DW
0.5 | 1 | 2 | 5 | 10

Vessel type	Double wall, borosilicate glass
Total volume	0.8 l 1.6 l 3 l 6.7 l 12.9 l
Working volume	0.25 – 0.5 l 0.3 – 1 l 0.6 – 2 l 1 – 5 l 2 – 10 l
Speed range	1 – 1400 rpm 1 – 2000 rpm 1 – 2200 rpm 1 – 1500 rpm 1 – 800 rpm
Temperature control	Thermostat, 5 – 75 °C
pH sensor (resolution)	0 – 14 pH (0.01 pH)
DO sensor (resolution)	0 – 200 % (0.01 %)
Sparger type	Micro sparger, 5 µm
Stirrer type	3-blade segment stirrer
Material in contact with product	AISI 316L, borosilicate glass 3.3, silicone USP class VI

① HABITAT ferment dw 0.5

Price on request
Ident. No. 0010007655

② HABITAT ferment dw 1

Price on request
Ident. No. 0010007657



① HABITAT ferment sw 2

Price on request
Ident. No. 0010007658

② HABITAT ferment dw 2

Price on request
Ident. No. 0010007659



① HABITAT ferment sw 5

Price on request
Ident. No. 0010007660

② HABITAT ferment dw 5

Price on request
Ident. No. 0010007661



HABITAT ferment dw 10

Price on request
Ident. No. 0010007662



TECHNICAL DATA

Vessel type	Single wall, borosilicate glass
Total volume	3 l 6.7 l
Working volume	0.6 – 2 l 1 – 5 l
Speed range	1 – 2200 rpm 1 – 1500 rpm
Temperature control	Heating sleeve + cooling finger + chiller, 5 – 65 °C
pH sensor (resolution)	0 – 14 pH (0.01 pH)
DO sensor (resolution)	0 – 200 % (0.01 %)
Sparger type	Ring sparger, 0.5 mm
Stirrer type	6-blade disc stirrer (rushton)
Material in contact with product	AISI 316L, borosilicate glass 3.3, silicone USP class VI

HABITAT FERMENT SW
2 | 5

Vessel type	Single wall, borosilicate glass
Total volume	3 l 6.7 l
Working volume	0.6 – 2 l 1 – 5 l
Speed range	1 – 2200 rpm 1 – 1500 rpm
Temperature control	Heating sleeve + cooling finger + chiller, 5 – 65 °C
pH sensor (resolution)	0 – 14 pH (0.01 pH)
DO sensor (resolution)	0 – 200 % (0.01 %)
Sparger type	Ring sparger, 0.5 mm
Stirrer type	6-blade disc stirrer (rushton)
Material in contact with product	AISI 316L, borosilicate glass 3.3, silicone USP class VI

HABITAT FERMENT DW
0.5 | 1 | 2 | 5 | 10

Vessel type	Double wall, borosilicate glass
Total volume	0.8 l 1.6 l 3 l 6.7 l 12.9 l
Working volume	0.25 – 0.5 l 0.3 – 1 l 0.6 – 2 l 1 – 5 l 2 – 10 l
Speed range	1 – 1400 rpm 1 – 2000 rpm 1 – 2200 rpm 1 – 1500 rpm 1 – 800 rpm
Temperature control	Circulator, 5 – 75 °C
pH sensor (resolution)	0 – 14 pH (0.01 pH)
DO sensor (resolution)	0 – 200 % (0.01 %)
Sparger type	Ring sparger, 0.5 mm
Stirrer type	6-blade disc stirrer (rushton)
Material in contact with product	AISI 316L, borosilicate glass 3.3, silicone USP class VI



HA.gv.sw.1

HA.gv.dw.5

Product	Description	Ident. No.	Price
VESSELS			
HA.gv.sw.0.5	Glass vessel, single-wall, for 0.5 l	0020105898	
HA.gv.sw.1	Glass vessel, single-wall, for 1 l	0020106410	
HA.gv.sw.2	Glass vessel, single-wall, for 2 l	0020105973	
HA.gv.sw.5	Glass vessel, single-wall, for 5 l	0020106412	
HA.gv.dw.0.5	Glass vessel, double-wall, for 0.5 l	0020106409	On request
HA.gv.dw.1	Glass vessel, double-wall, for 1 l	0020106411	
HA.gv.dw.2	Glass vessel, double-wall, for 2 l	0020105974	
HA.gv.dw.5	Glass vessel, double-wall, for 5 l	0020106413	
HA.gv.dw.10	Glass vessel, double-wall, for 10 l	0020106414	

STANDS



HA.ls.2

HA.sfr.250

HA.ls.2	Lid stand, for 2 l	0035004067	
HA.ls.10	Lid stand, for 5 l and 10 l	0035004059	
HA.sfr.250	Sample flask rack, for 250 ml bottles	0020110862	
HA.vh.0.5	Vessel holder, for 0.5 l	0020105897	On request
HA.vh.1	Vessel holder, for 1 l	0020106404	
HA.vh.2	Vessel holder, for 2 l	0020105972	
HA.vh.5	Vessel holder, for 5 l	0020106406	
HA.vh.10	Vessel holder, for 10 l	0020106408	

REACTOR LIDS



HA.lc.2

HA.lc.0.5	Lid complete, for 0.5 l	0020106425	
HA.lc.1	Lid complete, for 1 l	0020106426	
HA.lc.2	Lid complete, for 2 l	0020106427	On request
HA.lc.5	Lid complete, for 5 l	0020106428	
HA.lc.10	Lid complete, for 10 l	0020106429	

DRIVE SHAFTS & MOTORS



HA.ds.s.2

HA.ds.s.0.5	Drive shaft, standard coupling, for 0.5 l	0035003856	
HA.ds.s.1	Drive shaft, standard coupling, for 1 l	0035003814	
HA.ds.s.2	Drive shaft, standard coupling, for 2 l	0035003760	On request
HA.ds.s.5	Drive shaft, standard coupling, for 5 l	0035003594	
HA.ds.s.10	Drive shaft, standard coupling, for 10 l	0035003703	



HA.mt.s.2

HA.mt.s.10

Product	Description	Ident. No.	Price
DRIVE SHAFTS & MOTORS			
HA.mt.s.2	Small motor, standard coupling, for 0.5 l, 1 l and 2 l	0035003757	
HA.mt.s.10	Big motor, standard coupling, for 5 and 10 l	0035003694	
HA.ds.m.0.5	Drive shaft with motor, magnetic coupling, for 0.5 l	0020117598	
HA.ds.m.1	Drive shaft with motor, magnetic coupling, for 1 l	0020117685	On request
HA.ds.m.2	Drive shaft with motor, magnetic coupling, for 2 l	0020117686	
HA.ds.m.5	Drive shaft with motor, magnetic coupling, for 5 l	0020117542	
HA.ds.m.10	Drive shaft with motor, magnetic coupling, for 10 l	0020117543	

SENSORS



HA.s.tm.10

HA.s.ph.10

HA.s.tm.1	Temperature sensor, for 0.5 l and 1 l	0035004128	
HA.s.tm.2	Temperature sensor, for 2 l	0035004123	
HA.s.tm.5	Temperature sensor, for 5 l	0035004125	
HA.s.tm.10	Temperature sensor, for 10 l	0035004127	
HA.s.ph.0.5	pH sensor, for 0.5 l	0035004274	
HA.s.ph.1	pH sensor, for 1 l	0035004275	
HA.s.ph.2	pH sensor, for 2 l	0035004276	
HA.s.ph.5	pH sensor, for 5 l	0035003648	
HA.s.ph.10	pH sensor, for 10 l	0035004277	
HA.s.do.0.5	DO sensor, for 0.5 l	0035004278	
HA.s.do.1	DO sensor, for 1 l	0035004279	
HA.s.do.2	DO sensor, for 2 l	0035004280	On request
HA.s.do.5	DO sensor, for 5 l	0035004281	
HA.s.do.10	DO sensor, for 10 l	0035004282	
HA.s.fo	Foam sensor	0035004028	
HA.s.lv.1	Level sensor, for 0.5 l and 1 l	0035004160	
HA.s.lv.2	Level sensor, for 2 l	0020107107	
HA.s.lv.5	Level sensor, for 5 l	0020103648	
HA.s.lv.10	Level sensor, for 10 l	0020107108	
HA.s.tb.cpl.1	Turbidity sensor, complete, for 1 l	0020115415	
HA.s.tb.cpl.2	Turbidity sensor, complete, for 2 l	0020115416	
HA.s.tb.cpl.5	Turbidity sensor, complete, for 5 l	0020115417	
HA.s.tb.cpl.10	Turbidity sensor, complete, for 10 l	0020115418	



HA.s.do.1

HA.s.fo



HA.s.lv.5

Product	Description	Ident. No.	Price
SENSORS			
HA.s.co.cpl.1	CO ₂ sensor, complete, for 1 l	0020115419	
HA.s.co.cpl.2	CO ₂ sensor, complete, for 2 l	0020115420	
HA.s.co.cpl.10	CO ₂ sensor, complete, for 5 l and 10 l	0020115421	On request
HA.s.cd.cpl.1	Conductivity sensor, complete, for 1 l	0020115422	
HA.s.cd.cpl.2	Conductivity sensor, complete, for 2 l	0020115423	
HA.s.cd.cpl.5	Conductivity sensor, complete, for 5 l	0020115424	
HA.s.cd.cpl.10	Conductivity sensor, complete, for 10 l	0020115425	
STIRRING ELEMENTS			
HA.ip.pi.0.5	3-pitched blade impeller, for 0.5 l	0035003949	
HA.ip.pi.1	3-pitched blade impeller, for 1 l	0035003946	
HA.ip.pi.2	3-pitched blade impeller, for 2 l	0035003941	
HA.ip.pi.5	3-pitched blade impeller, for 5 l	0035003938	
HA.ip.pi.10	3-pitched blade impeller, for 10 l	0035003944	On request
HA.ip.b.0.5	6-blade segment impeller, for 0.5 l	0035003863	
HA.ip.b.1	6-blade segment impeller, for 1 l	0035003821	
HA.ip.b.2	6-blade segment impeller, for 2 l	0035003766	
HA.ip.b.5	6-blade segment impeller, for 5 l	0035003633	
HA.ip.b.10	6-blade segment impeller, for 10 l	0035003720	
SPARGER			
HA.sp.m.0.5	Micro Sparger, 5 µm, for 0.5 l	0020102905	
HA.sp.m.1	Micro Sparger, 5 µm, for 1 l	0035003918	
HA.sp.m.2	Micro Sparger, 5 µm, for 2 l	0020102879	
HA.sp.m.5	Micro Sparger, 5 µm, for 5 l	0020102839	
HA.sp.m.10	Micro Sparger, 5 µm, for 10 l	0020103001	On request
HA.sp.r.0.5	Ring Sparger, 0.5 mm, for 0.5 l	0035003860	
HA.sp.r.1	Ring Sparger, 0.5 mm, for 1 l	0035003818	
HA.sp.r.2	Ring Sparger, 0.5 mm, for 2 l	0035003763	
HA.sp.r.5	Ring Sparger, 0.5 mm, for 5 l	0035003639	
HA.sp.r.10	Ring Sparger, 0.5 mm, for 10 l	0035003718	
TEMPERATURE CONTROL			
HA.hbl.0.5	Heating blanket, for 0.5 l	0035004032	
HA.hbl.1	Heating blanket, for 1 l	0035004031	
HA.hbl.2	Heating blanket, for 2 l	0035004029	
HA.hbl.5	Heating blanket, for 5 l	0035004030	On request
HA.cf.2	Cooling finger, for 2 l	0020112117	
HA.cf.5	Cooling finger, for 5 l	0020112120	

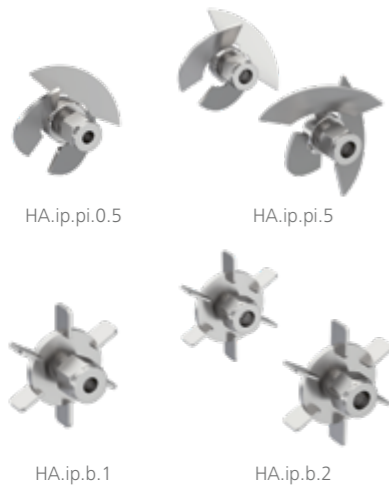

Product	Description	Ident. No.	Price
SAMPLE COLLECTION			
HA.hp.s.0.5	Harvest pipe, straight, for 0.5 l	0035003898	
HA.hp.s.1	Harvest pipe, straight, for 1 l	0035003901	
HA.hp.s.2	Harvest pipe, straight, for 2 l	0035003903	On request
HA.hp.s.5	Harvest pipe, straight, for 5 l	0035003905	
HA.hp.s.10	Harvest pipe, straight, for 10 l	0035003907	
BAFFLE			
HA.ba.0.5	Baffle, for 0.5 l	0035003868	
HA.ba.1	Baffle, for 1 l	0035003827	
HA.ba.2	Baffle, for 2 l	0035003774	On request
HA.ba.5	Baffle, for 5 l	0035003645	
HA.ba.10	Baffle, for 10 l	0035003730	
FOAM BREAKER			
HA.fb.s.0.5	Foam breaker 4-blade, straight for 0.5 l	0020110951	
HA.fb.s.1	Foam breaker 4-blade, straight for 1 l	0020114008	
HA.fb.s.2	Foam breaker 4-blade, straight for 2 l	0020110995	On request
HA.fb.s.5	Foam breaker 4-blade, straight for 5 l	0020111000	
HA.fb.s.10	Foam breaker 4-blade, straight for 10 l	0020114011	
SPIN FILTER			
HA.fi.10.1	Spin filter, 10 µm, for 1 l	0020114014	
HA.fi.10.2	Spin filter, 10 µm, for 2 l	0020111027	
HA.fi.10.5	Spin filter, 10 µm, for 5 l	0020111052	
HA.fi.10.10	Spin filter, 10 µm, for 10 l	0020114069	
HA.fi.20.1	Spin filter, 20 µm, for 1 l	0020114060	
HA.fi.20.2	Spin filter, 20 µm, for 2 l	0020111022	On request
HA.fi.20.5	Spin filter, 20 µm, for 5 l	0020111061	
HA.fi.20.10	Spin filter, 20 µm, for 10 l	0020114080	
HA.fi.40.1	Spin filter, 40 µm, for 1 l	0020114064	
HA.fi.40.2	Spin filter, 40 µm, for 2 l	0020111015	
HA.fi.40.5	Spin filter, 40 µm, for 5 l	0020111065	
HA.fi.40.10	Spin filter, 40 µm, for 10 l	0020114085	





Tablet 10.x inch



LED Panel

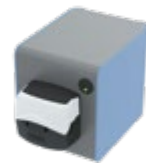

HA.ep



HA.sf.500



HA.fd



HA.cn

Product	Description	Ident. No.	Price
OTHER ACCESSORIES			
Tablet 10.x inch	Tablet, software included	0020106577	
LED Panel	for photobioreactor, set consisting of 2 pcs.	0025004168	
HA.cn	Condenser	0020106610	
HA.cab.sw	Cable and hose set for single-walled glass vessels	0020107110	
HA.cab.dw	Cable and hose set for double-walled glass vessels	0020107111	
HA.sf.250	Sample flask 250 ml	0020107065	
HA.sf.500	Sample flask 500 ml	0020110852	On request
HA.sf.1000	Sample flask 1000 ml	0020110853	
HA.ap	Air pump, 230V	0020106152	
HA.ep	External peristaltic pump	0020101836	
HA.fd	Feeding port	0020107770	
HA.ino	Port for inoculation	0035004598	
HA.sam	Syringe set, sterile	0035004014	
PC 1.3	Cable, L 1.5 m	0025005322	

HABITAT PROCESS 50L /// Stirred Single-Use Bioreactor

With HABITAT process 50L you ensure the transition from laboratory to production scale.

The stirred single-use bioreactor HABITAT process 50L is used for cultivation of animal cells and thus enables the production of monoclonal antibodies, recombinant proteins, vaccines and viral vectors as cell culture products for our customers.

Scale-up

Interested? Contact us!
process@ika.de



In a unique endeavor, IKA owner René Stiegelmann has partnered up with Professor Phil S. Baran of the world-renowned Scripps Research Institute in La Jolla, California (USA). Over three years, engineers and chemists have worked hand in hand to develop a product combining two divisions of chemistry communities: the Electrochemical and the mainstream Synthetic Organic Chemistry Communities that traditionally did not have much in common.

ELECTRASYN 2.0 PACKAGE

/// Your chemistry has potential

Update your ElectraSyn 2.0 firmware on a regular basis to benefit from the latest features



reddot award 2018
winner



ElectraSyn 2.0 essentially combines three products in one and will facilitate the mass adoption of electrochemistry for preparative organic synthesis: a potentiostat, an analytical device and a magnetic stirrer. It is a compact, user friendly and cost effective platform for organic chemists to explore electrochemistry.

The ElectraSyn 2.0 Ready-To-Go package includes all that is required to for your first experiment: Potentiostat, including a single 10 ml vial, vial holder, stir plate attachment, and a set of electrodes (graphite).

ElectraSyn 2.0 Package

EUR 3.873,00

Ident. No. 0020008980

Ready-To-Go
package



ElectraSyn 2.0 pro Package

EUR 4.552,00

Ident. No. 0040003261



ElectraSyn 2.0 Package

Electrosynthesis basic device

Vial holder

Vial, 10 ml complete

2 electrodes (graphite)

Stir plate attachment

Stir bar

ElectraSyn 2.0 pro Package

Electrosynthesis basic device

Vial holder

Vial, 10 ml complete

2 electrodes (graphite)

Stir plate attachment

Stir bar

Set of CV electrodes:

› CV glassy carbon

› CV platinum

› Silver reference electrode

TECHNICAL DATA

Stirring speed range 50 – 1500 rpm

Maximum voltage output 30 V | 20 V | 10 V

Maximum current output 100 mA

Display TFT

Permissible ambient temperature 5 – 50 °C

Dimensions (W × H × D) 130 × 150 × 250 mm

Protection class according to
DIN EN 60529 IP 40

ELECTRASYN 2.0 PACKAGE | PRO PACKAGE

ELECTRASYN 2.0 APP

Monitor reactions as well as CV graphs, transmit experiments, receive software update notifications, access the online IKA store for ordering supplies, and receive latest video tutorial updates. ElectraSyn 2.0 is a device that improves over time through regular software updates available through a simple app. You can also use the app to configure your ElectraSyn 2.0 by shopping available devices and accessories.





Carousel complete



GOGO Module



e-Hive



Fritte Sample Set

Product	Description	Ident. No.	Price
ATTACHMENTS			
Carousel	Attachment for multi measurements	0020017512	EUR 3.240,00
Carousel complete	Attachment for multi measurements, incl. glass vials	0040005427	EUR 4.508,00
e-Hive	Screening platform with a maximum of 24 reactions	0040004945	EUR 4.049,00
GOGO Module	Universal extension for ElectraSyn 2.0	0040006052	EUR 891,00
Pro-Seal	Vial cap for gas exchange	0040007151	EUR 634,00
Pro-Divide	Reaction cell for divided electrochemistry	0040006482	EUR 969,00
Calibration cap	Calibration cap for ElectraSyn 2.0	0040007388	EUR 303,00

ACCESSORIES PRO-DIVIDE

Fritte Set, 1 µm	Glass frit, 2 pcs.	0020102632	EUR 105,00
Fritte Set, 5 µm	Glass frit, 2 pcs.	0020102633	EUR 48,50
Fritte Set, 10 µm	Glass frit, 2 pcs.	0020102634	EUR 56,00
Fritte Sample Set	Kit of 1/5/10 µm glass frit, 1 pc. each	0020101403	EUR 102,00

ELECTRODES FOR E-HIVE

Copper electrode inner	Anode copper (24 pcs.)	0040007427	EUR 508,00
Graphite electrode inner	Anode graphite (24 pcs.)	0040007430	EUR 203,00
Stainless electrode inner	Anode stainless steel (24 pcs.)	0040007429	EUR 405,00
Copper electrode outer	Cathode copper (24 pcs.)	0040007436	EUR 885,00
Graphite electrode outer	Cathode graphite (24 pcs.)	0040007438	EUR 699,00
Stainless electrode outer	Cathode stainless steel (24 pcs.)	0040007443	EUR 249,00



Fritte Set



Glass vial 5 ml

Glass vial complete 10 ml



ElectraSyn 2.0 Complete Starter Kit



Microvial 1 ml

Microvial 2 ml



ElectraSyn 2.0 Micro Starter Kit complete

Product	Description	Ident. No.	Price
VIALS / ELECTRODES			
Glass vial complete 5 ml	Glass vial 5 ml incl. lid, glass and magnetic bar	0040003171	EUR 184,00
Glass vial complete 10 ml	Glass vial 10 ml incl. lid, glass and magnetic bar	0040003170	EUR 171,00
Glass vial complete 20 ml	Glass vial 20 ml incl. lid, glass and magnetic bar	0040003168	EUR 172,00
Glass vials 5 ml	Glass vial 5 ml, set of 10	0040003327	EUR 418,00
Glass vials 10 ml	Glass vial 10 ml, set of 10	0040003325	EUR 284,00
Glass vials 20 ml	Glass vial 20 ml, set of 10	0040003324	EUR 308,00
ElectraSyn 2.0 Electrode Starter Kit	Kit of glassy carbon, set of 2 + 8 other electrodes, each set of 12	0020017204	EUR 2.181,00
ElectraSyn 2.0 Complete Vial Kit	Kit of 5 ml, 10 ml and 20 ml vials complete, 10 spare vials of each volume	0010003810	EUR 1.533,00
ElectraSyn 2.0 Vials only Kit	Kit of 10 × 5 ml, 10 × 10 ml, 10 × 20 ml vials	0010003811	EUR 1.010,00
ElectraSyn 2.0 Complete Starter Kit	Kit of 5 ml, 10 ml, 20 ml vials complete; 10 spare vials of each volume; 9 electrodes (each 12 pcs., glassy carbon 2 pcs.)	0040004013	EUR 3.711,00
Electrode CV Package	Kit of electrodes (CV glassy carbon, CV platinum, reference electrode)	0040002864	EUR 680,00
MICROVIALS / MICROELECTRODES			
Microvial 1 ml	Glass vial 1 ml incl. lid, glass and magnetic bar	0040003294	EUR 229,00
Microvial 2 ml	Glass vial 2 ml incl. lid, glass and magnetic bar	0040003295	EUR 229,00
Micro glass vials 1 ml	Glass vial 1 ml, set of 10	0020017207	EUR 596,00
Micro glass vials 2 ml	Glass vial 2 ml, set of 10	0020017206	EUR 588,00
ElectraSyn 2.0 Micro electrode Starter Kit	Kit of glassy carbon, set of 2 + 7 other electrodes, each set of 12	0040004016	EUR 3.205,00
ElectraSyn 2.0 microvials only	Kit 10 × 1 ml, 10 × 2 ml vials	0040004103	EUR 1.184,00
ElectraSyn 2.0 Microvial Kit complete	Kit of 1 ml and 2 ml vials complete, 10 spare vials of each volume	0040004014	EUR 1.642,00
ElectraSyn 2.0 Micro Starter Kit complete	Kit of 1 ml and 2 ml vials complete; 10 spare vials of each volume; 8 electrodes (each 12 pcs., glassy carbon 2 pcs.)	0040004015	EUR 4.618,00



Product	Ident. No.	Price
ELEKTRODEN		
① Electrode graphite (12 pcs.)	0040002858	EUR 242,00
② Electrode glassy carbon (2 pcs.)	0040002842	EUR 182,00
Electrode lead bronze (2 pcs.)	0020016076	EUR 184,00
Electrode lead (12 pcs.)	0040002843	EUR 454,00
Electrode tungsten (2 pcs.)	0040002845	EUR 462,00
③ Electrode niobium (2 pcs.)	0040002846	EUR 172,00
④ Electrode copper (12 pcs.)	0040002847	EUR 125,00
Electrode magnesium (12 pcs.)	0040002848	EUR 444,00
Electrode titanium (12 pcs.)	0040002849	EUR 411,00
Electrode zinc (12 pcs.)	0040002850	EUR 411,00
Electrode stainless steel (12 pcs.)	0040002851	EUR 112,00
⑤ Electrode CV Platinum (2 pcs.)	0040002852	EUR 161,00
Electrode platinum foil (2 pcs.)	0040005015	EUR 807,00
Electrode platinum on ceramics (2 pcs.)	0040006753	EUR 445,00
Electrode gold plated (2 pcs.)	0040002853	EUR 414,00
⑥ Electrode silver plated (2 pcs.)	0040002854	EUR 134,00
Electrode aluminum (12 pcs.)	0040003174	EUR 244,00
Electrode boron doped diamond (2 pcs.)	0040002856	EUR 718,00
Electrode tin (12 pcs.)	0040002857	EUR 431,00
⑦ Electrode nickel (12 pcs.)	0040002859	EUR 283,00
⑧ Electrode RVC foam (12 pcs.)	0040002860	EUR 408,00
Electrode nickel foam (12 pcs.)	0040002861	EUR 100,00
Electrode cobalt (2 pcs.)	0040003385	EUR 114,00
⑨ Electrode reference (1 pc.)	0040002865	EUR 294,00
Electrode CV glassy carbon (1 pc.)	0040002863	EUR 161,00

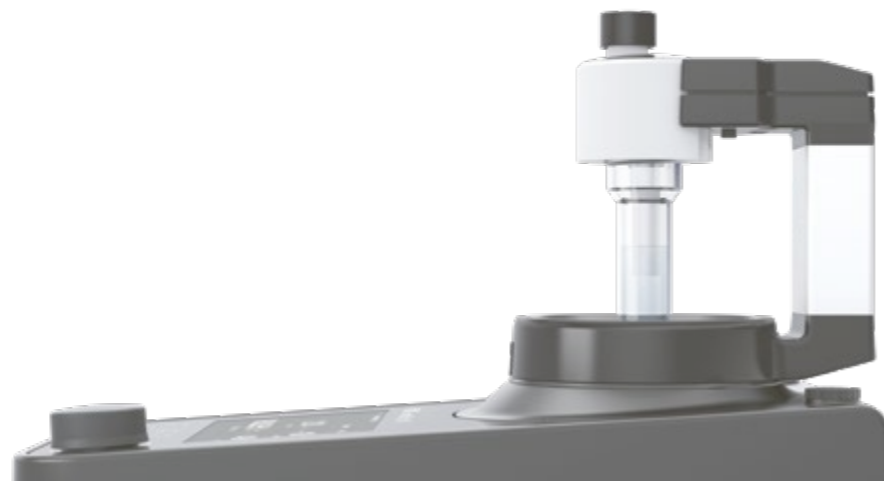

Product	Ident. No.	Price
MICROELECTRODES		
① Microelectrode aluminum (12 pcs.)	0040004029	EUR 120,00
Microelectrode boron-doped diamond (2 pcs.)	0040004036	EUR 1.015,00
② Microelectrode cobalt (2 pcs.)	0040004039	EUR 173,00
③ Microelectrode copper (12 pcs.)	0040004027	EUR 290,00
④ Microelectrode glassy carbon (2 pcs.)	0040004022	EUR 223,00
⑤ Microelectrode gold (2 pcs.)	0040004034	EUR 290,00
Microelectrode graphite SK-50 (12 pcs.)	0040004021	EUR 294,00
Microelectrode lead (12 pcs.)	0040004028	EUR 1.203,00
⑥ Microelectrode lead bronze (12 pcs.)	0040004030	EUR 313,00
Microelectrode magnesium (12 pcs.)	0040004025	EUR 705,00
Microelectrode nickel (12 pcs.)	0040004023	EUR 924,00
⑦ Microelectrode nickel foam (12 pcs.)	0040004101	EUR 130,00
⑧ Microelectrode niobium (2 pcs.)	0040004032	EUR 293,00
Microelectrode silver (2 pcs.)	0040004035	EUR 100,00
Microelectrode stainless steel (12 pcs.)	0040004024	EUR 206,00
Microelectrode tin (12 pcs.)	0040004037	EUR 809,00
⑨ Microelectrode titanium (12 pcs.)	0040004033	EUR 705,00
Microelectrode tungsten (2 pcs.)	0040004031	EUR 132,00
Microelectrode zinc (12 pcs.)	0040004026	EUR 705,00

Screening System Package (8 cells)

EUR 13.886,00

Ident. No. 0040003642



Screening System Package (6 cells)

EUR 15.088,00

Ident. No. 0040003631



TECHNICAL DATA

SCREENING SYSTEM PACKAGE (6 | 8 CELLS)

CONTINUOUSLY ADJUSTABLE POWER SUPPLY

Voltage output 0 – 32 V (± 1 mV)

Supply voltage 115 or 230 V
(50 Hz / 60 Hz)

MAGNETIC STIRRER

Speed range 0 – 1500 rpm

REACTION CELLS

Number of cells 6 (divided cell) or
8 (undivided cell)

Cell volume of undivided cell 10.7 ml

Cell volume of divided cell
(per chamber) 12.7 ml

Material PTFE

Temperature control Yes (RT to 100 °C)

IKA Screening System

The IKA Screening System is perfectly suited for constant current electrosynthesis in “multibatch” mode. The combination of both divided and undivided batch cells enables you to quickly carry out research on multiple electroconversions at the same time. In addition, you can combine the system with other equipment in the laboratory.

Screening System Package (8 cells)

Reaction block

Single Cells

Aluminum block

IKA Plate (RCT digital)
Magnetic stirrer, including
PT 1000 temperature sensor

Crown stirrer 8 pcs.

Cable Set with crocodile clamps

Step-up transformer

Screening System Package (6 cells)

Reaction block

Divided Cell

Aluminum block

IKA Plate (RCT digital)
Magnetic stirrer, including
PT 1000 temperature sensor

Crown stirrer 12 pcs.

Cable Set with crocodile clamps

Step-up transformer



Reaction block with 6 divided cells



Reaction block with 8 undivided cells



Divided cell



LABORATORY SOFTWARE

labworldsoft® 6 Screening System

EUR 1.259,00

Ident. No. 0020023690

Product	Ident. No.	Price
ACCESSORIES SCREENING SYSTEM		
Reaction block with 6 divided cells	0020015936	EUR 2.593,00
Reaction block with 8 undivided cells	0020015943	EUR 1.426,00
Set of reaction cells (6 divided cells)	0040003647	EUR 2.333,00
Set of reaction cells (8 undivided cells)	0040003648	EUR 1.166,00
SC.MF Manifold	0020110119	EUR 218,00
SC.MF.CP.UDIV Manifold cap, for undivided cells	0020110375	EUR 189,00
SC.MF.CP.DIV Manifold cap, for divided cells	0020110376	EUR 183,00
ELECTRODES		
Electrode 0.7 boron doped diamond (8 pcs.)	0040003932	EUR 5.052,00
Electrode 0.7 glassy carbon (16 pcs.)	0040003670	EUR 1.252,00
Electrode 0.7 graphite SK-50 (16 pcs.)	0040003954	EUR 215,00
Electrode 0.7 platinum (8 pcs.)	0040003678	EUR 768,00
Electrode 0.7 platinum on ceramics (2 pcs.)	0020023860	EUR 455,00
Electrode 0.7 gold (8 pcs.)	0040003934	EUR 486,00
Electrode 0.7 silver (8 pcs.)	0040003938	EUR 377,00
Electrode 0.7 nickel foam (16 pcs.)	0040003935	EUR 103,00
Electrode 0.7 graphite V2100 (16 pcs.)	0040003669	EUR 861,00
Electrode 0.7 nickel (16 pcs.)	0040003671	EUR 586,00
Electrode 0.7 stainless steel (8 pcs.)	0040003672	EUR 324,00
Electrode 0.7 lead (16 pcs.)	0040003673	EUR 639,00
Electrode 0.7 lead bronze (8 pcs.)	0040003674	EUR 420,00
Electrode 0.7 copper (8 pcs.)	0040003675	EUR 278,00
Electrode 0.7 magnesium (16 pcs.)	0040003677	EUR 586,00
Electrode 0.7 zinc (16 pcs.)	0040003680	EUR 553,00
Electrode 0.7 aluminium (16 pcs.)	0040003682	EUR 690,00
Electrode 0.7 cobalt (8 pcs.)	0040003933	EUR 399,00
Electrode 0.7 niobium (8 pcs.)	0040003936	EUR 365,00
Electrode 0.7 tin (8 pcs.)	0040003939	EUR 317,00
Electrode 0.7 titanium (8 pcs.)	0040003940	EUR 291,00
Electrode 0.7 tungsten (8 pcs.)	0040003941	EUR 420,00
Electrode 0.7 RVC (16 pcs.)	0040003937	EUR 508,00
Electrode 0.7 Sampler Kit incl. 7 × 2 electrodes*	0040004509	EUR 1.868,00
Electrode 0.7 Starter Kit incl. 9 × 1 electrode**	0040003646	EUR 5.740,00
FURTHER ACCESSORIES		
Electrode 0.7 power supply	0040003604	EUR 5.184,00
SC 1.1 Cable (1 – 4)	0040003663	EUR 170,00
SC 1.2 Cable (5 – 8)	0020018590	EUR 170,00
SC 2.1 Crocodile clip for cable set	0040003630	EUR 34,00
labworldsoft® 6 Screening System	0020023690	EUR 1.259,00

*BDD, cobalt, gold, silver, niobium,
tungsten, titanium**graphite V2100, glassy carbon, magnesium, tin,
nickel foam, nickel, lead, lead bronze, copper

Continuous flow synthesis is rapidly becoming an essential part of any workflow within the chemical and pharmaceutical industries due to the many advantages over batch chemistry that it provides. Chemists trust in the increased reproducibility of reactions, higher process reliability, rapid modification and testing of chemical processes and conditions, and last but not least, increased product quality and yield. IKA FLOW system is integrated with the most common lab equipment for the transition to continuous flow synthesis. Compared to other expensive and commercially available flow chemistry systems which have to include flow capacity supporting equipment, the flexibility of IKA FLOW lowers its cost.

IKA FLOW SYSTEM

/// Flow chemistry your way

HIGHLY FLEXIBLE

IKA FLOW System is highly flexible due to its variety of accessories and consumables.

EASILY INTEGRATED

Further proof of IKA FLOW System's flexibility is its compatibility with any fume hood gas to put pressure on the reaction process.

LIGHT-WEIGHT AND COMPACT DESIGN

IKA FLOW System has one of the smallest footprints compared to other flow reactors on the market and is easy to move in a laboratory to where it is needed.

CONSISTENT, PREDICTABLE AND SAFE

With the IKA FLOW System, there are no separate pumps required. The system can be integrated with the gas outlet from the fume hood. The continuous gas moves fluid through the system, hardly causing any risk of pressure drop or fluctuation in the system during reaction.



CONSTANTLY DEVELOPING

IKA FLOW System is just the start of your journey into the incorporation of continuous flow synthesis in your laboratory. Our R&D team is currently working on new modular solutions.

IKA FLOW System

EUR 5.512,00

Ident. No. 0020100742



IKA FLOW System Package

Glass bottle
Capillary set
Heating block
CDR.PP standard (2x)
Tubing set

TECHNICAL DATA	IKA FLOW SYSTEM
Max. solvent volume	500 ml
Connection type	Push-to-connect // Screw fittings
Max. input pressure	1 mPa
Input pressure	Pressure of the gas from fume hood
Max. working pressure	137 kPa
Max. working temperature	100 °C
Working pressure	Pressure of the gas in solvent bottle
Material	304 stainless steel // Nylon (PA)
Dimensions (W × H × D)	250 × 375 × 140 mm
Weight	2.7 kg

Name	Description	Ident. No.	Price
------	-------------	------------	-------

ACCESSORIES IKA FLOW

REACTOR SETS

CDR.PP narrow	Disc reactor set, polypropylene, narrow, 2 pcs.	0020102705	EUR 96,00
CDR.PP standard	Disc reactor set, polypropylene, standard, 2 pcs.	0020102637	EUR 96,00
CDR.PVDF narrow	Disc reactor set, polyvinylidene difluoride, narrow, 2 pcs.	0020102706	EUR 208,00
CDR.PVDF standard	Disc reactor set, polyvinylidene difluoride, standard, 2 pcs.	0020102638	EUR 208,00

MIXING CHIPS

MX.PP	Mixing chip set, polypropylene	0020103092	EUR 61,00
MX.PVDF	Mixing chip set, polyvinylidene difluoride	0020103093	EUR 131,00

OTHER ACCESSORIES

Heating Block	Heating block for up to four disc reactors	0020103369	EUR 220,00
Capillary Set	Capillary set, 4 pcs.	0020103091	EUR 239,00



CDR.PP narrow

CDR.PVDF standard

MX.PP

MX.PVDF

Heating Block

Capillary Set

Almost everything about this mixing expert is new. TWISTER can be transformed from a single-position to a multi-position magnetic stirrer. With one attachment, it stirs even the smallest volumes reliably. With another, it becomes a vortex shaker with numerous attachments.

TWISTER

/// From magnetic stirrer to shaker and back



reddot winner 2022

THE TRANSFORMER

First, the small, elegant plate on your lab bench is a magnetic stirrer that packs a punch. Because it easily manages 3000 revolutions and can reliably stir even the smallest volumes. And then a single attachment turns it into a shaker. At only low additional cost and without taking up any extra space. And because TWISTER is so clever, it even becomes a multi-position magnetic stirrer in no time at all: You can connect up to 30 units together in any desired clusters. That's up to 270 stirring positions for the smallest volumes.

NEW OPERATING CONCEPT AND INNOVATIVE DISPLAY

TWISTER enables a new type of interaction between user and laboratory device: all information is intuitively displayed via the 360° LED circle display without any alpha-numerical display. Mixing can be started via the touch display or, thanks to beaker recognition, by placing or touching the beaker or attachment.

/// UNIVERSAL MIXING DRIVE

TWISTER SET 1

EUR 419,00
Ident. No. 0020027010



TWISTER SET 2

EUR 787,00
Ident. No. 0020027388



TWISTER SET 3

EUR 1.154,00
Ident. No. 0020027389



TWISTER SET 4

EUR 1.522,00
Ident. No. 0020027390



TECHNICAL DATA	TWISTER SET 1	TWISTER SET 2	TWISTER SET 3	TWISTER SET 4
Number of stirring positions	1	2	3	4
Stirring quantity min. / max. per stirring position (H ₂ O)	0.005 l / 5 l	0.005 l / 5 l	0.005 l / 5 l	0.005 l / 5 l
Direction of rotation	right / left	right / left	right / left	right / left
Speed range	100 – 3000 rpm	100 – 3000 rpm	100 – 3000 rpm	100 – 3000 rpm
Intermittent mode	Yes	Yes	Yes	Yes
Viscosity trend measurement	Yes	Yes	Yes	Yes
Vessel detection	Yes	Yes	Yes	Yes
Set-up plate material	glass	glass	glass	glass
Set-up plate dimensions	124 × 124 mm	124 × 124 mm	124 × 124 mm	124 × 124 mm
Dimensions (W × H × D)	135 × 24 × 135 mm	135 × 24 × 135 mm	135 × 24 × 135 mm	135 × 24 × 135 mm
Protection class according to DIN EN 60529	IP 66	IP 66	IP 66	IP 66

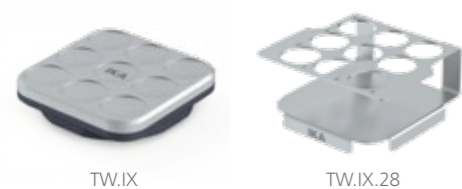

TW.IX

TW.IX.28



TW.VX

STICKMAX II



MS 3.1

MS 1.21



MS 1.31

MS 1.32



MS 3.5



TW.PWR.2

MS 1.32

Product	Description	Ident. No.	Price
TWISTER ACCESSORIES			
TWISTER Add-on unit	Magnetic stirrer, without power supply	0020112621	EUR 377,00
TW.IX	Stirring attachment, 9 positions	0020103426	EUR 293,00
TW.VX	Shaking attachment	0020110145	EUR 235,00
TW.IX.28	Vessel holder for jars (28 mm)	0020112966	EUR 58,00
TW.IX.23	Vessel holder for jars (23 mm)	0020112965	EUR 58,00
STICKMAX II	Universelle Haftmatte für TWISTER	0020112736	EUR 42,00
TW.IX.ANTISLIP	Anti-slip mat for TW.IX	0020111461	EUR 11,80
UNIVERSAL ATTACHMENTS AND BASIC HOLDERS			
MS 3.3	Universal attachment	0003426600	EUR 20,50
TUBE INSERTS			
MS 3.1	Standard attachment	0003426300	EUR 20,50
MS 1.21	One-hand insert	L001540	EUR 29,50
MS 1.30	Attachment for 0.5 ml tubes	0025005776	EUR 62,00
MS 1.31	Test tube insert, 14 × Ø 10 mm	L001840	EUR 64,50
MS 1.32	Test tube insert, 6 × Ø 12 mm	L001850	EUR 64,50
MS 1.33	Test tube insert, 4 × Ø 16 mm	L001860	EUR 64,50
MS 1.34	Test tube insert	L001830	EUR 31,50
MICROTITER PLATE AND PCR ATTACHMENTS			
MS 3.4	Microtiter plate attachment	0003426400	EUR 64,50
MS 3.5	PCR plate attachment, 96-well	0003428000	EUR 64,50
STIRRING BARS, PTFE COATED, POWER			
IKAFLON 10 power ellipse	Magnetic stirring bar, ellipse, rare earth, 6 × 10 mm, 5 pcs.	0020110607	EUR 24,50
IKAFLON 15 power ellipse	Magnetic stirring bar, ellipse, rare earth, 10 × 15 mm, 5 pcs.	0020110747	EUR 36,00
IKAFLON 25 power ellipse	Magnetic stirring bar, ellipse, rare earth, 14 × 25 mm, 5 pcs.	0020110748	EUR 47,50
POWER SUPPLY AND DATA CABLES			
TW.PWR.0	Power supply incl. device plug (≤ 2 devices)	0020121797	EUR 72,50
TW.PWR.1	Power supply ≤ 4 devices	0025005565	EUR 58,00
TW.PWR.2	Power supply ≤ 4 units	0020116436	EUR 125,00
TW.CABLE	Extension cable 0.5 m	0020025856	EUR 37,00



Watch
TWISTER video



We believe that even a laboratory classic can always be made better: The magnetic stirrer was invented more than seven decades ago, but never before have the world's best-selling stirrers been as powerful, energy-efficient, safe and durable as IKA's modern magnetic stirrers. We have developed devices for mixing tasks in a wide range of volumes and viscosities, with and without heating function and even for multiple syntheses in up to 36 vessels simultaneously.

RCT basic

/// Bestseller reloaded

Here comes the new one: RCT basic is a classic among magnetic stirrers and is launched on the market in an updated version tested by TÜV SÜD. It is even safer and more robust than its predecessor and is equipped with numerous new features



▶ Watch RCT video

EVEN MORE SAFETY

In accordance with the DIN EN 61010-2-010 standard, RCT basic meets all safety requirements for laboratory equipment for heating substances. The unit monitors all safety-relevant components and is therefore suitable for unattended operation. User safety is guaranteed even if individual components fail. As a consequence, RCT basic not only carries the CE certification, but has also been tested and certified by TÜV SÜD.

NEW FEATURES

The new RCT basic offers a USB and RS232 interface and can be integrated into labworld-soft® 6 laboratory software, for example, for digital networking, monitoring and control.

In addition, RCT basic has an improved fast temperature control. Compared to the previous model, the operating temperature range has been extended: a connected external sensor can display temperatures down to -20 °C. Operation at these low temperatures is possible without restriction, as is use under typical ambient conditions in the chemical industry

PROVEN FEATURES REMAIN

Of course, the new RCT basic also has a long service life, a powerful motor and a strong magnetic connection. And by meeting all safety standards, it is of course also suitable for unattended operation.

/// MAGNETIC STIRRERS WITH GLASS SURFACE

RCT basic

EUR 974,00

Ident. No. 0025005927



IKA Plate (RCT digital)

EUR 1.137,00

Ident. No. 0025004601



RCT basic ready-to-go Solution

EUR 1.002,00

Ident. No. 0010011525

RCT basic ETS-D5 Solution

EUR 1.312,00

Ident. No. 0010011496

RCT basic Synthesis Solution 250

EUR 1.259,00

Ident. No. 0010011505

RCT basic Synthesis Solution 500

EUR 1.259,00

Ident. No. 0010011502

RCT basic Synthesis Solution 1000

EUR 1.312,00

Ident. No. 0010011508

Further package information on page 163



TECHNICAL DATA	RCT BASIC	IKA PLATE (RCT DIGITAL)
Stirring quantity max. (H ₂ O)	20 l	20 l
Direction of rotation	right	right / left
Speed range	50 – 1500 rpm	50 – 1500 rpm
Heat output	600 W	600 W
Heating temperature	RT + device self heating – 340 °C	RT + device self heating – 310 °C
Set-up plate material	Aluminium alloy	Aluminium alloy
Set-up plate dimensions	Ø 135 mm	Ø 135 mm
Dimensions (W × H × D)	160 × 85 × 270 mm	160 × 85 × 270 mm
Protection class according to DIN EN 60529	IP 42	IP 42
Interfaces	USB, RS 232	USB, RS 232

RCT 5 digital
 EUR 1.166,00
 Ident. No. 0020002704

850 W
 Power



C-MAG HS 7 control
 EUR 1.166,00
 Ident. No. 0020002694



① **C-MAG HS 4 digital**
 EUR 832,00
 Ident. No. 0004240200

①



② **C-MAG HS 7 digital**
 EUR 974,00
 Ident. No. 0003487000

③ **C-MAG HS 10 digital**
 EUR 1.166,00
 Ident. No. 0004240400

① **C-MAG HS 4**
 EUR 668,00
 Ident. No. 0003581000

② **C-MAG HS 7**
 EUR 733,00
 Ident. No. 0003581200

③ **C-MAG HS 10**
 EUR 1.002,00
 Ident. No. 0003581400

②



C-MAG HS 7 Package EUR 1.136,00
 0009015900

C-MAG HS 7 Magnetic Stirrer with heating and ceramic plate

ETS-D5 Electronic contact thermometer

H 38 Holding rod

H 44 Boss head clamp

H 16 V Support rod

TECHNICAL DATA	RCT 5 DIGITAL	C-MAG HS 7 CONTROL	C-MAG HS 4 7 10 DIGITAL	C-MAG HS 4 7 10
Stirring quantity max. (H ₂ O)	20 l	20 l	5 l 10 l 15 l	5 l 10 l 15 l
Speed range	50 – 1500 rpm	50 – 1500 rpm	100 – 1500 rpm	100 – 1500 rpm
Heat output	850 W	1000 W	250 W 1000 W 1500 W	250 W 1000 W 1500 W
Heating temperature	RT + device self heating – 310 °C	RT + device self heating – 500 °C	50 – 500 °C	50 – 500 °C
Set-up plate material	Aluminum with ceramic coating	Ceramic	Ceramic	Ceramic
External Temperature control	137 × 137 mm	180 × 180 mm	PT 1000	– ETS-D5 ETS-D5
Dimensions (W × H × D)	160 × 85 × 270 mm	220 × 88 × 354 mm	150 × 105 × 260 mm 215 × 105 × 330 mm 300 × 105 × 415 mm	150 × 105 × 260 mm 220 × 105 × 335 mm 300 × 105 × 415 mm
Protection class according to DIN EN 60529	IP 42	IP 21	IP 21	IP 21

RET basic
 EUR 1.467,00
 Ident. No. 0003622000



① **RH basic**
 EUR 668,00
 Ident. No. 0005019700

② **RH basic white**
 EUR 748,00
 Ident. No. 0005029700

③ **RH basic 2**
 EUR 466,00
 Ident. No. 0003339000



① **RET control-visc**
 EUR 1.838,00
 Ident. No. 0005020000

② **RET control-visc white**
 EUR 1.897,00
 Ident. No. 0005030000

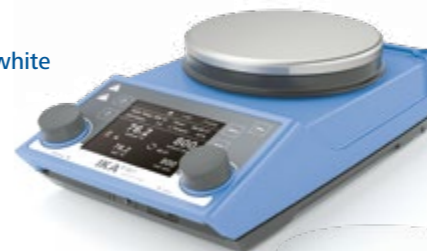

① **RH digital**
 EUR 801,00
 Ident. No. 0005019800

② **RH digital white**
 EUR 872,00
 Ident. No. 0004678000



Weighing function & pH measurement

TECHNICAL DATA	RET BASIC	RET CONTROL-VISC WHITE	RH BASIC BASIC WHITE RH BASIC 2	RH DIGITAL DIGITAL WHITE
Stirring quantity max. (H ₂ O)	20 l	20 l	15 l 10 l	15 l
Speed range	50 – 1700 rpm	50 – 1700 rpm	100 – 2000 rpm	100 – 2000 rpm
Heat output	600 W	600 W	600 W 400 W	600 W
Heating temperature	RT + device self heating – 340 °C	RT + device self heating – 340 °C	50 – 320 °C Room temp. °C – 320 °C	50 – 320 °C
Set-up plate material	Stainless steel 1.4301	Stainless steel 1.4301 Coated	Stainless steel 1.4301 RH basic white: coated	Stainless steel 1.4301 RH digital white: coated
Connection for ext. temperature sensor	PT 1000	PT 1000	ETS-D5 ETS-D5 –	ETS-D5
Dimensions (W × H × D)	160 × 95 × 270 mm	160 × 85 × 270 mm	160 × 100 × 250 mm 168 × 105 × 220 mm	160 × 100 × 250 mm
Protection class according to DIN EN 60529	IP 42	IP 42	IP 21	IP 21

/// MULTI-POSITION MAGNETIC STIRRER

① **RO 5**
EUR 1.686,00
Ident. No. 0003690500

Adjustable reverse operation

② **RO 10**
EUR 1.946,00
Ident. No. 0003691000

③ **RO 15**
EUR 2.720,00
Ident. No. 0003692500



① **RT 5**
EUR 2.855,00
Ident. No. 0003690600

Multi-position hotplate stirrer, for synchronous heating and stirring

② **RT 10**
EUR 3.769,00
Ident. No. 0003691100

③ **RT 15**
EUR 4.740,00
Ident. No. 0003692600



/// INDUSTRIAL MAGNETIC STIRRER

① **Midi MR 1 digital**
EUR 4.018,00
Ident. No. 0025002968

② **Maxi MR 1 digital**
EUR 4.407,00
Ident. No. 0025002978



I-MAG
Industrial magnetic stirrer
EUR 3.998,00
Ident. No. 0020014226



TECHNICAL DATA	RO 5 RO 10 RO 15	RT 5 RT 10 RT 15	MIDI MR 1 DIGITAL MAXI MR 1 DIGITAL	I-MAG
Stirring quantity max. (H ₂ O)	0.4 l per stirring position	0.4 l per stirring position	50 l 150 l	300 l
Speed range	0 – 1200 rpm	0 – 1000 rpm	0 – 1000 rpm 0 – 600 rpm	100 – 1500 rpm
Heating temperature range	–	RT – 120 °C	–	–
Set-up plate material	Stainless steel 1.4301	Aluminium alloy	Stainless steel 1.4301	Stainless steel 1.4301
Set-up plate dimensions	120 × 470 mm 190 × 470 mm 280 × 470 mm	110 × 495 mm 180 × 495 mm 270 × 495 mm	350 × 350 mm 500 × 500 mm	260 × 260 mm
Dimensions (W × H × D)	120 × 60 × 570 mm 190 × 60 × 570 mm 280 × 60 × 570 mm	120 × 60 × 610 mm 190 × 60 × 610 mm 280 × 60 × 610 mm	360 × 110 × 430 mm 505 × 110 × 585 mm	260 × 70 × 300 mm
Protection class according to DIN EN 60529	IP 40	IP 40	IP 21	IP 64 / IP 22

① **topolino**
EUR 139,00
Ident. No. 0003368000

② **topolino mobil**
EUR 333,00
Ident. No. 0003381300

③ **Mini MR standard**
EUR 286,00
Ident. No. 0025004132



KMO 3 basic
EUR 754,00
Ident. No. 0020004631



Illuminated, flat stirring plate



IKA myPlate
EUR 401,00
Ident. No. 0025005156

Design the set-up plate yourself



① **lab disc white**
EUR 366,00
Ident. No. 0003907500

② **color squid white**
EUR 401,00
Ident. No. 0003671000

③ **big squid white**
EUR 401,00
Ident. No. 0003672000



① **C-MAG MS 4**
EUR 623,00
Ident. No. 0003582200

② **C-MAG MS 7**
EUR 685,00
Ident. No. 0003582400

③ **C-MAG MS 10**
EUR 936,00
Ident. No. 0003582600



TECHNICAL DATA	TOPOLINO MINI MR STANDARD	KMO 3 BASIC IKA MYPLATE	LAB DISC	C-MAG MS 4 7 10
Stirring quantity max. (H ₂ O)	0.25 l 1 l	5 l 1.5 l	0.8 l	5 l 10 l 15 l
Speed range	500 – 1800 rpm 0 – 2500 rpm	10 – 1500 rpm 100 – 2500 rpm	15 – 1500 rpm	100 – 1500 rpm
Set-up plate material	Synthetic (PP) Polyester	Glass	Polyester	Ceramic
Set-up plate dimensions	Ø 80 mm 115 × 115 mm	140 × 120 mm Ø 135 mm	Ø 100 mm	100 × 100 mm 180 × 180 mm 260 × 260 mm
Dimensions (W × H × D)	95 × 37 × 115 mm 115 × 37 × 129 mm	153 × 62.5 × 227 mm 152 × 30 × 164 mm	116 × 12 × 175 mm	150 × 105 × 260 mm 220 × 105 × 335 mm 300 × 105 × 415 mm
Protection class according to DIN EN 60529	IP 21 IP 42	IP 42 IP 54	IP 65	IP 21



Product	Ident. No.	Price
TEMPERATURE SENSORS		
Stainless steel		
PT 1000.60	0003516800	EUR 157,00
PT 1000.80	0004443000	EUR 166,00
PT 100.70	0020000440	EUR 152,00
Glass-coated		EUR 173,00
PT 1000.70	0003736000	EUR 345,00
PT 100.51	0002600300	EUR 222,00
SafeCoat (PFA, PTFE)		EUR 352,00
PT 1000.90	0004480600	EUR 345,00
PT 100.53	0004499700	EUR 399,00
Dual		
PT 1000.50	0003367600	EUR 335,00
PT 1000.51	0003377700	EUR 399,00

ELECTRONIC CONTACT THERMOMETERS

ETS-D5	0003378000	EUR 454,00
ETS-D6	0003378100	EUR 668,00

SENSORS FOR ETS-D5 / ETS-D6

H 62.51	0002735451	EUR 228,00
H 66.51, glass coated	0002735551	EUR 333,00
H 66.53, coated	0004499900	EUR 267,00
H 70, extension cable	0002735600	EUR 231,00



RET control-visc	RET basic	IKA Plate (RCT digital)	RCT basic	C-MAG HS 7 control	C-MAG HS digital 4 7 10	C-MAG HS 7 10	RH digital basic
-	•	•	•	•	•	-	-
-	+	+	+	+	+	-	-
•	-	-	-	-	-	-	-
-	+	+	+	+	+	-	-
+	-	-	-	-	-	-	-
-	+	+	+	+	+	-	-
+	-	-	-	-	-	-	-
+	-	-	-	-	-	-	-

-	+	+	+	+	-	+	+
-	+	+	+	+	-	+	+

+ Compatible | - Not compatible | • Included in delivery



Product	Hole Ø	Dimensions	Ident. No	Price
DRY HEATING BLOCK SQUARE SERIES				
H 135.10 Square carrier without handle	–	160 × 160 mm	0025000832	EUR 173,00
H 135.11 Square carrier with handle	–	160 × 160 mm	0004448200	EUR 308,00
H 135.101 Block 16 × 4 ml	15.2 mm	79 × 79 mm	0025000626	EUR 83,00
H 135.102 Block 16 × 8 ml	17.5 mm	79 × 79 mm	0025000627	EUR 83,00
H 135.103 Block 9 × 16 ml	20.5 mm	79 × 79 mm	0025000628	EUR 83,00
H 135.104 Block 4 × 20 ml	28.5 mm	79 × 79 mm	0025000629	EUR 83,00
H 135.105 Block 4 × 30 ml	28.5 mm	79 × 79 mm	0025000630	EUR 83,00
H 135.106 Block 4 × 40 ml	28.5 mm	79 × 79 mm	0025000631	EUR 83,00
H 135.107 Block 100 ml	–	79 × 79 mm	0025000632	EUR 83,00
H 135.108 Block 250 ml	–	79 × 79 mm	0025000633	EUR 83,00

Square carrier with handle:
H 135.11

H 135.104

Flask carrier with handle:
H 135.21Flask carrier without
handle: H 135.25

Inlay: H 135.301



Inlay: H 135.401



Inlay: H 135.501

Product	Max. outer Ø	Inner Ø	Ident. No	Price
100 ML FLASK HEATING BLOCK SERIES				
H 135.20 Flask carrier 100 ml without handle	142 mm	–	0025000634	EUR 147,00
H 135.21 Flask carrier 100 ml with handle	142 mm	–	0004448300	EUR 281,00
H 135.201 Flask inlay 10 ml	–	33.8 mm	0025000636	EUR 83,00
H 135.202 Flask inlay 25 ml	–	43.8 mm	0025000637	EUR 83,00
H 135.203 Flask inlay 50 ml	–	52.8 mm	0025000638	EUR 83,00
250 ML FLASK HEATING BLOCK SERIES				
H 135.25 Flask carrier 250 ml without handle	142 mm	–	0025003280	EUR 188,00
H 135.26 Flask carrier 250 ml with handle	142 mm	–	0020007954	EUR 321,00
500 ML FLASK HEATING BLOCK SERIES				
H 135.30 Flask carrier 500 ml without handle	142 mm	–	0025000639	EUR 201,00
H 135.31 Flask carrier 500 ml with handle	142 mm	–	0004448400	EUR 333,00
H 135.301 Flask inlay 100 ml	–	66.3 mm	0025000641	EUR 83,00
H 135.302 Flask inlay 250 ml	–	88 mm	0025000642	EUR 83,00
1000 ML FLASK HEATING BLOCK SERIES				
H 135.40 Flask carrier 1000 ml without handle	166.3 mm	–	0025000833	EUR 252,00
H 135.41 Flask carrier 1000 ml with handle	166.3 mm	–	0004448500	EUR 387,00
H 135.401 Flask inlay 500 ml	–	108 mm	0025000644	EUR 147,00
2000 ML FLASK HEATING BLOCK SERIES				
H 135.50 Flask carrier 2000 ml without handle	194.7 mm	–	0025000834	EUR 347,00
H 135.51 Flask carrier 2000 ml with handle	194.7 mm	–	0004448600	EUR 480,00
H 135.501 Flask inlay 1000 ml	–	131.8 mm	0025000645	EUR 213,00

Product	Dimensions	Ident. No	Price	Product	Dimensions	Ident. No	Price
IKAFLON® ROUND PTFE-COATED				IKAFLON® CROSS PTFE-COATED			
10 round (5 pcs.)	10 × 6 mm	0004488600	EUR 10,20	10 cross (5 pcs.)	10 × 10 mm	0004496200	EUR 17,70
15 round (5 pcs.)	15 × 6 mm	0004488700	EUR 11,50	20 cross (5 pcs.)	20 × 20 mm	0004496400	EUR 25,50
20 round (5 pcs.)	20 × 8 mm	0004488800	EUR 14,00	25 cross (5 pcs.)	25 × 25 mm	0004496600	EUR 28,50
25 round (5 pcs.)	25 × 8 mm	0004488900	EUR 16,50	30 cross (5 pcs.)	30 × 30 mm	0004496800	EUR 36,00
30 round (5 pcs.)	30 × 8 mm	0004489000	EUR 16,50	38 cross (5 pcs.)	38 × 38 mm	0004497000	EUR 44,50
40 round (5 pcs.)	40 × 8 mm	0004489100	EUR 17,70	IKAFLON® BONE PTFE-COATED			
50 round (5 pcs.)	50 × 8 mm	0004489200	EUR 19,10	37 bone (5 pcs.)	35 × 8 × 20 mm	0004497200	EUR 64,50
80 round (5 pcs.)	80 × 10 mm	0004489300	EUR 48,50	54 bone (5 pcs.)	55 × 8 × 20 mm	0004497400	EUR 78,00
110 round (1 pc.)	108 × 27 mm	0000793300	EUR 117,00	IKAFLON® BEAKER PTFE-COATED			
155 round (1 pc.)	153 × 27 mm	0001129000	EUR 131,00	74 (1 pc.)	(Ø × H): 74 × 29 mm with 60 × 9	0004497800	EUR 369,00
IKAFLON® ROUND GLASS-COATED				IKAFLON® CROWN PTFE-COATED			
25 round (5 pcs.)	25 × 6 mm	0004492200	EUR 33,00	9 crown (5 pcs.)	9 × 6 mm	0004498400	EUR 15,30
40 round (5 pcs.)	40 × 8 mm	0004492600	EUR 33,00	TRIKA® PTFE-COATED			
50 round (5 pcs.)	50 × 8 mm	0004492800	EUR 35,00	25 Trika (5 pcs.)	25 × 8 mm	0004499300	EUR 15,30
IKAFLON® SLIDE ROUND				35 Trika (5 pcs.)	35 × 9 mm	0004499400	EUR 25,50
25 slide (5 pcs.)	25 × 6 mm	0004493800	EUR 14,00	55 Trika (5 pcs.)	55 × 14 mm	0004499500	EUR 38,00
30 slide (5 pcs.)	30 × 6 mm	0004494000	EUR 14,00	80 Trika (5 pcs.)	80 × 17 mm	0004499600	EUR 52,50
40 slide (5 pcs.)	40 × 8 mm	0004494200	EUR 26,50	SET OF MAGNETIC STIRRING BARS			
50 slide (5 pcs.)	50 × 8 mm	0004494400	EUR 29,50	RS 1		0001358600	EUR 136,00
IKAFLON® POWER				RS 2		0004499100	EUR 155,00
20 power (5 pcs.)	20 × 6 mm	0004493000	EUR 33,00	STIRRING BAR REMOVER			
30 power (5 pcs.)	30 × 6 mm	0004493200	EUR 48,50	RSE	Stirring bar remover	0001293100	EUR 88,50
50 power (5 pcs.)	50 × 8 mm	0004493400	EUR 59,00	IKAFLON® ELLIPSE PTFE-COATED			
IKAFLON® ELLIPSE PTFE-COATED				20 ellipse (5 pcs.)	20 × 10 mm	0004494600	EUR 22,50
25 ellipse (5 pcs.)	25 × 12 mm	0004494800	EUR 25,50	25 ellipse (5 pcs.)	25 × 16 mm	0004495000	EUR 33,00
30 ellipse (5 pcs.)	32 × 16 mm	0004495200	EUR 41,00	35 ellipse (5 pcs.)	35 × 15 mm	0004495400	EUR 51,50
40 ellipse (5 pcs.)	40 × 20 mm	0004495600	EUR 72,50	40 ellipse (5 pcs.)	40 × 20 mm	0004495800	EUR 72,50
50 ellipse (5 pcs.)	50 × 20 mm	0004496000	EUR 125,00	50 ellipse (5 pcs.)	50 × 20 mm	0004496200	EUR 125,00

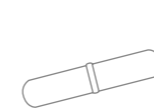
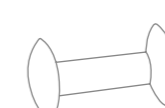
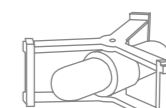
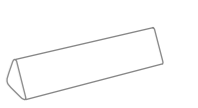
IKAFLON® round
PTFE-coatedIKAFLON® ellipse
PTFE-coatedIKAFLON® cross
PTFE-coatedIKAFLON® bone
PTFE-coatedIKAFLON® beaker
PTFE-coated

TRIKA® PTFE-coated



WiCo RET control-visc



Cover RET control-visc



IB R RO 15 eco



LABLIFT m



IKA Plate Adapter



LABORATORY SOFTWARE

labworldsoft® 6 Starter

EUR 5.056,00

Ident. No. 0020019397

labworldsoft® 6 Pro

EUR 11.537,00

Ident. No. 0020017366

labworldsoft® is a laboratory software to control lab devices, automate processes, and to document your measurements and results. The software provides access to a huge library of different laboratory devices. labworldsoft® does not integrate only IKA laboratory devices, but supports several other devices from different manufacturers as well. You stay flexible in the choice of your lab devices you want to use and profit from the whole device range of the laboratory world.

Product	Description	Ident. No.	Price
WIRELESS-CONTROLLED OPERATING UNIT			
WiCo RET control-visc	Wireless remote control	0020007259	EUR 470,00
COVERS			
H 102	Cover for RH basic	0004281600	EUR 22,50
H 103	Cover for RH digital	0004299100	EUR 22,50
H 100	Cover for RET basic	0003661000	EUR 22,50
H 104	Cover for RET control-visc	0004209500	EUR 22,50
H 105	Cover for RCT basic and digital	0025008136	EUR 22,50
MAINS CABLES			
H 11	Mains cable Euro plug	0001091500	EUR 39,00
H 11	Mains cable USA plug	0003564500	EUR 39,00
H 11	Mains cable UK plug	0002410700	EUR 39,00
H 11	Mains cable CH plug	0001091600	EUR 39,00
H 11	Mains cable IN plug	0003923600	EUR 39,00
PLASTIC BATH FOR MAGNETIC STIRRER RO 15			
IB R RO 15 eco	Plastic bath, size L, 25 l volume	0020006341	EUR 1.025,00
LABLIFT			
LABLIFT m	Up to 25 kg (max. static load)	0004022400	EUR 351,00
IKA PLATE ADAPTER			
IKA Plate Adapter	Heating block adapter for RCT 5 digital, C-MAG 7 and 10	0025001022	EUR 208,00
BEAKER CAP			
BC 1000	Beaker cap	0020003417	EUR 20,50



H 3000



HG 600



H 16.3



H 44



I-MAG cart



I-MAG SP 300

Product	Description	Ident. No.	Price
OIL BATH ATTACHMENTS			
H 29	Oil bath attachment, 1 l	0002829400	EUR 265,00
H 30	Oil bath attachment, 1.5 l	0002829500	EUR 293,00
BEAKERS, STAINLESS STEEL			
H 1000	Beaker, stainless steel, 1 l	0004444401	EUR 448,00
H 1500	Beaker, stainless steel, 1.5 l	0004444501	EUR 462,00
H 3000	Beaker, stainless steel, 3 l	0004444503	EUR 475,00
H 5000	Beaker, stainless steel, 5 l	0004444505	EUR 559,00
HEATING JACKETS			
HG 600	Heating jacket for beaker 600 ml	0020003416	EUR 131,00
HG 1000	Heating jacket for beaker 1000 ml	0020003415	EUR 156,00
HOLDERS			
H 16 V	Support rod	0001545100	EUR 82,00
H 16.3	Extension for support rod	0025000622	EUR 22,50
H 44	Boss head clamp	0002437700	EUR 39,00
H 38	Holding rod	0003547700	EUR 36,00
ACCESSORIES FOR I-MAG			
IKAFLON 90 slide	Magnetic stirring bar, PTFE round, with sliding ring (PEEK), 90 x 30 mm, 1 pc.	0020102963	EUR 107,00
IKAFLON 140 slide	Magnetic stirring bar, PTFE round, with sliding ring (PEEK), 140 x 30 mm, 1 pc.	0020110382	EUR 212,00
IKAFLON 118 float	Magnetic stirring drive, PPS round, Ø 118 mm, 1 pc.	0020100638	EUR 494,00
RSE XL	Stirring bar remover for I-MAG	0020100641	EUR 411,00
I-MAG SP 150	Platform extension for I-MAG, for barrels up to 150 liters	0020102994	EUR 470,00
I-MAG SP 300	Platform extension for I-MAG, for barrels up to 300 liters	0020102996	EUR 705,00
I-MAG cart	Transport trolley and platform for I-MAG, for barrels up to 300 liters	0025008091	EUR 1.633,00
I-MAG BR	Bracket for stand rod I-MAG	0020110383	EUR 58,00
I-MAG UHC	Universal holder for I-MAG controller	0020110381	EUR 205,00
I-MAG EXT 3	Extension cable for I-MAG, 3 m	0020115558	EUR 262,00
H 28 V	Support rod for I-MAG	0020119439	EUR 167,00

IKA overhead stirrers are strong, sturdy and safe because we understand the most important aspects during development. From low to high viscosities, and with up to 200 liters of stirring volume, all mixing and stirring tasks constitute no challenge for our stirrers. This is a good foundation for differentiated functionalities, which include: a safety circuit, a clear display, convenient control using labworldsoft® laboratory software and a wide range of stirring tools. Whether it is propeller stirrers, anchor stirrers or spiral stirrers – you will find the right tool for all applications in our range.

Shaft protection included

NANOSTAR 7.5 DIGITAL

/// Perfect basic functionality in the most compact of spaces



Original size

With 30% less volume and weighing just 0.8 kg, the NANOSTAR 7.5 digital overhead stirrer is even more space-saving than the MICROSTAR 7.5 digital – yet with the same performance rating.

CONSTANT TORQUE

NANOSTAR 7.5 digital guarantees an absolutely constant torque over the entire speed range of 50 – 2000 rpm.

EASE OF OPERATION

Operation takes place using a stable rotary knob. The display clearly shows the rotational speed.

RAPID UPDATES

Regular software updates can be undertaken rapidly and simply via the USB interface.

/// COMPACT OVERHEAD STIRRERS FOR LIGHT STIRRING TASKS

NANOSTAR 7.5 digital

EUR 957,00
Ident. No. 0025004356



MICROSTAR 7.5 digital

EUR 1.037,00
Ident. No. 0025004715



MICROSTAR 7.5 control

EUR 1.358,00
Ident. No. 0025001984



Speed range:
50 – 2000 rpm

MICROSTAR 15 digital

EUR 1.115,00
Ident. No. 0025004883



MICROSTAR 15 control

EUR 1.432,00
Ident. No. 0025001986



MICROSTAR 30 digital

EUR 1.166,00
Ident. No. 0025004884



MICROSTAR 30 control

EUR 1.481,00
Ident. No. 0025001987



Temperature sensor included

TECHNICAL DATA	NANOSTAR 7.5 DIGITAL	MICROSTAR 7.5 DIGITAL CONTROL	MICROSTAR 15 DIGITAL CONTROL	MICROSTAR 30 DIGITAL CONTROL
Stirring quantity max. (H ₂ O)	5 l	5 l	10 l	20 l
Speed range	0 / 50 – 2000 rpm	0 / 50 – 2000 rpm 0 / 30 – 2000 rpm	0 / 50 – 1000 rpm 0 / 30 – 1000 rpm	0 / 50 – 500 rpm 0 / 30 – 500 rpm
Viscosity max.	4000 mPas	4000 mPas	8000 mPas	20 000 mPas
Torque max. at stirring shaft	7.5 Ncm	7.5 Ncm	15 Ncm	30 Ncm
Temperature measuring range	–	– -10 – 350 °C	– -10 – 350 °C	– -10 – 350 °C
Torque measurement	–	– Trend	– Trend	– Trend
Chuck range diameter	0.5 – 8.2 mm	0.5 – 8.2 mm	0.5 – 8.2 mm	0.5 – 8.2 mm
Display	LED	LED LCD	LED LCD	LED LCD
Dimensions (W x H x D)	53 x 147 x 130 mm	60 x 173 x 126 mm 60 x 173 x 136 mm	60 x 173 x 126 mm 60 x 173 x 136 mm	60 x 173 x 126 mm 60 x 173 x 136 mm
Protection class according to DIN EN 60529	IP 54	IP 54	IP 54	IP 54

/// COMPACT OVERHEAD STIRRERS FOR LIGHT STIRRING TASKS

MINISTAR 20 digital

EUR 1.115,00
Ident. No. 0025004885



MINISTAR 20 control

EUR 1.432,00
Ident. No. 0025001988



MINISTAR 40 digital

EUR 1.245,00
Ident. No. 0025004886



MINISTAR 40 control

EUR 1.555,00
Ident. No. 0025001989



Vibration sensor included

MINISTAR 80 digital

EUR 1.375,00
Ident. No. 0025004887



Power package: 80 Ncm

MINISTAR 80 control

EUR 1.678,00
Ident. No. 0025001990



TECHNICAL DATA	MINISTAR 20 DIGITAL CONTROL	MINISTAR 40 DIGITAL CONTROL	MINISTAR 80 DIGITAL CONTROL
Stirring quantity max. (H ₂ O)	15 l	25 l	50 l
Speed range	0 / 50 – 2000 rpm	0 / 50 – 1000 rpm 0 / 30 – 1000 rpm	0 / 50 – 500 rpm 0 / 30 – 500 rpm
Viscosity max.	10 000 mPas	30 000 mPas	60 000 mPas
Torque max. at stirring shaft	20 Ncm	40 Ncm	80 Ncm
Temperature measuring range	- -10 – 350 °C	- -10 – 350 °C	- -10 – 350 °C
Torque measurement	- Trend	- Trend	- Trend
Chuck range diameter	0.5 – 8.2 mm	0.5 – 8.2 mm	0.5 – 8.2 mm
Display	LED LCD	LED LCD	LED LCD
Dimensions (W × H × D)	70 × 193 × 147 mm 70 × 193 × 154 mm	70 × 193 × 147 mm 70 × 193 × 154 mm	70 × 193 × 147 mm 70 × 193 × 154 mm
Protection class according to DIN EN 60529	IP 54	IP 54	IP 54

/// OVERHEAD STIRRERS FOR LIGHT STIRRING TASKS

EUROSTAR 20 digital

EUR 1.207,00
Ident. No. 0004442000



EUROSTAR 40 digital

EUR 1.399,00
Ident. No. 0004444000



Quiet operation with brushless DC motor

EUROSTAR 60 digital

EUR 1.761,00
Ident. No. 0004446000



EUROSTAR 60 control

EUR 2.569,00
Ident. No. 0004440000



/// POWERFUL OVERHEAD STIRRERS FOR UNIVERSAL STIRRING TASKS

EUROSTAR 100 digital

EUR 2.515,00
Ident. No. 0004238100



EUROSTAR 100 control

EUR 3.248,00
Ident. No. 0004028500



Left-right interval rotation

EUROSTAR 200 digital

EUR 3.331,00
Ident. No. 0003990000



EUROSTAR 200 control

EUR 3.866,00
Ident. No. 0003992000



TECHNICAL DATA	EUROSTAR 20 DIGITAL 40 DIGITAL	EUROSTAR 60 DIGITAL CONTROL	EUROSTAR 100 DIGITAL CONTROL	EUROSTAR 200 DIGITAL CONTROL
Stirring quantity max. (H ₂ O)	15 l 25 l	40 l	100 l	100 l
Speed range	0 / 30 – 2000 rpm	0 / 30 – 2000 rpm	0 / 30 – 1300 rpm	I: 0 / 6 – 400 rpm II: 30 – 2000 rpm
Viscosity max.	10 000 l 30 000 mPas	50 000 mPas	70 000 mPas	100 000 mPas
Torque max. at stirring shaft	20 Ncm 40 Ncm	60 Ncm	100 Ncm	I: 200 Ncm II: 40 Ncm
Chuck range diameter	0.5 – 10 mm	0.5 – 10 mm	0.5 – 10 mm	0.5 – 10 mm
Display	LED	LED TFT	LED TFT	LED TFT
Temperature measuring range	- -	- -10 – 350 °C	- -10 – 350 °C	- -10 – 350 °C
Dimensions (W × H × D)	86 × 248 × 208 mm	86 × 248 × 208 mm 86 × 267 × 230 mm	86 × 248 × 208 mm 86 × 267 × 230 mm	91 × 274 × 209 mm 91 × 297 × 231 mm
Protection class according to DIN EN 60529	IP 42	IP 42 IP 40	IP 42 IP 40	IP 42 IP 40

/// PILOT SCALE OVERHEAD STIRRERS

EUROSTAR 400 digital

EUR 4.179,00
Ident. No. 0004214000

EUROSTAR 400 control

EUR 4.668,00
Ident. No. 0004214100



/// HIGH SPEED OVERHEAD STIRRERS

EUROSTAR 20 high speed digital

EUR 2.463,00
Ident. No. 0004028600

EUROSTAR 20 high speed control

EUR 3.310,00
Ident. No. 0025001314



/// ULTRA HIGH TORQUE OVERHEAD STIRRERS

EUROSTAR 100 P4 control

EUR 4.544,00
Ident. No. 0025004384



EUROSTAR 200 P4 control

EUR 5.161,00
Ident. No. 0004090000

Extremely powerful stirrer for highly viscous applications



TECHNICAL DATA	EUROSTAR 400 DIGITAL CONTROL	EUROSTAR 20 HIGH SPEED DIGITAL CONTROL	EUROSTAR 100 P4 CONTROL	EUROSTAR 200 P4 CONTROL
Stirring quantity max. (H ₂ O)	150 l	20 l	100 l	100 l
Speed range	I: 6 – 400 rpm II: 30 – 2000 rpm	0 / 150 – 6000 rpm	10 – 300 rpm	I: 0 / 4 – 108 rpm II: 16 – 530 rpm
Viscosity max.	100 000 mPas	10 000 mPas	100 000 mPas	150 000 mPas
Torque max. at stirring shaft	I: 400 Ncm II: 80 Ncm	20 Ncm	320 Ncm	I: 660 Ncm II: 130 Ncm
Chuck range diameter	3 – 16 mm	–	0.5 – 10 mm	0.5 – 10 mm
Display	LED TFT	LED TFT	TFT	TFT
Temperature measuring range	– -10 – 350 °C	– -10 – 350 °C	-10 – 350 °C	-10 – 350 °C
Dimensions (W x H x D)	114 x 325 x 245 mm 114 x 345 x 268 mm	86 x 325 x 208 mm 86 x 325 x 230 mm	86 x 352 x 230 mm	91 x 379 x 231 mm
Protection class according to DIN EN 60529	IP 42 IP 40	IP 42 IP 40	IP 40	IP 40

/// MECHANICAL OVERHEAD STIRRERS

RW 20 digital

EUR 1.509,00
Ident. No. 0003593000



RW 28 digital

EUR 3.889,00
Ident. No. 0005040000



/// PILOT SCALE OVERHEAD STIRRER

RW 47 digital

EUR 7.007,00
Ident. No. 0004050000



TECHNICAL DATA	RW 20 DIGITAL	RW 28 DIGITAL	RW 47 DIGITAL
Stirring quantity max. (H ₂ O)	20 l	80 l	200 l
Speed range	I: 60 – 500 rpm II: 240 – 2000 rpm	I: 60 – 400 rpm II: 240 – 1400 rpm	I: 57 – 275 rpm II: 275 – 1300 rpm
Viscosity max.	10 000 mPas	50 000 mPas	100 000 mPas
Torque max. at stirring shaft	I: 150 Ncm II: 24 Ncm	I: 900 Ncm II: 300 Ncm	I: 3000 Ncm II: 620 Ncm
Chuck range diameter	0.5 – 10 mm	1 – 10 mm	3 – 16 mm
Display	LED	LED	LED
Dimensions (W x H x D)	88 x 294 x 212 mm	123 x 364 x 252 mm	145 x 465 x 358 mm
Protection class according to DIN EN 60529	IP 20	IP 40	IP 54

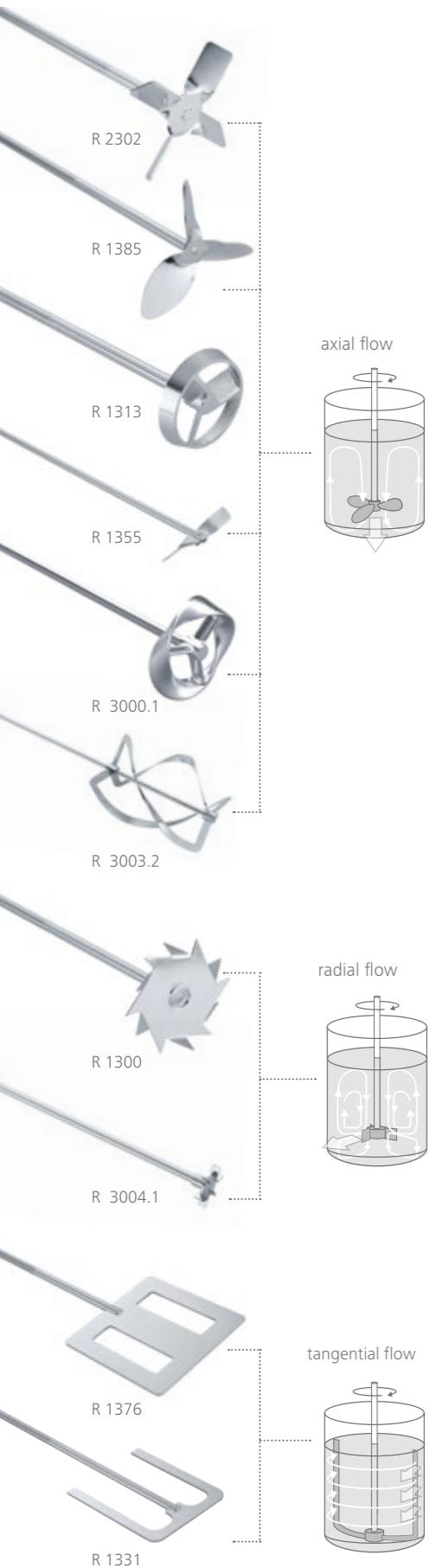

Product	Shaft length Shaft diameter Stirrer diameter	Max. speed	Ident. No.	Price
PROPELLER STIRRERS, 4-BLADED				
R 1342	350 8 50 mm	≤ 2000 rpm	0000741000	EUR 173,00
R 1345	550 8 100 mm	≤ 800 rpm	0000741300	EUR 213,00
R 2302	800 13 150 mm	≤ 600 rpm	0000739000	EUR 748,00
PROPELLER STIRRERS, 3-BLADED				
R 1381	350 8 45 mm	≤ 2000 rpm	0001296000	EUR 347,00
R 1382	350 8 55 mm	≤ 2000 rpm	0001295900	EUR 362,00
R 1385	550 10 140 mm	≤ 800 rpm	0000477700	EUR 347,00
R 1388	800 10 140 mm	≤ 400 rpm	0000477800	EUR 414,00
R 1389*	350 8 75 mm	≤ 800 rpm	0002343600	EUR 627,00
TURBINE STIRRERS				
R 1311	350 8 30 mm	≤ 2000 rpm	0002332900	EUR 234,00
R 1312	350 8 50 mm	≤ 2000 rpm	0002333000	EUR 299,00
R 1313	400 10 70 mm	≤ 800 rpm	0002333100	EUR 365,00
CENTRIFUGAL STIRRERS				
R 1352	350 8 60/15 mm	≤ 2000 rpm	0000756900	EUR 195,00
R 1355	550 8 100/24 mm	≤ 800 rpm	0001132700	EUR 260,00
DISSOLVER STIRRERS				
R 1300	350 8 80 mm	≤ 2000 rpm	0000513500	EUR 308,00
R 1302	350 10 100 mm	≤ 1000 rpm	0002387900	EUR 647,00
R 1303	350 8 40 mm	≤ 2000 rpm	0002746700	EUR 480,00
PADDLE STIRRERS				
R 1375	550 8 70 mm	≤ 800 rpm	0000757700	EUR 208,00
R 1376	550 10 150 mm	≤ 800 rpm	0000757800	EUR 414,00
R 2311	800 13 150 mm	≤ 600 rpm	0000739500	EUR 688,00
ANCHOR STIRRERS				
R 1330	350 8 45 mm	≤ 1000 rpm	0002022300	EUR 441,00
R 1331	350 8 90 mm	≤ 1000 rpm	0002022400	EUR 534,00
R 1333	550 10 150 mm	≤ 800 rpm	0002747400	EUR 869,00
MOEBIUS STIRRERS				
R 3000.1	565 10 100 mm	≤ 800 rpm	0020001192	EUR 480,00
R 3001.1	575 10 100 mm	≤ 800 rpm	0020001195	EUR 507,00
SPIRAL STIRRERS				
R 3003	350 8 50 mm	≤ 800 rpm	0020001203	EUR 389,00
R 3003.1	550 10 100 mm	≤ 800 rpm	0020001204	EUR 557,00
R 3003.2	800 10 150 mm	≤ 800 rpm	0020001205	EUR 713,00
BLADE STIRRERS				
R 3004	359 8 30 mm	≤ 1000 rpm	0020001206	EUR 338,00
R 3004.1	565 10 50 mm	≤ 1000 rpm	0020001207	EUR 467,00
R 3004.2	819 10 70 mm	≤ 1000 rpm	0020001208	EUR 597,00
PADDLE STIRRERS SCREW-TYPE STIRRERS				
R 1001	160 4 34 mm	2000 rpm	0000527400	EUR 183,00
R 1002	140 4 12 mm	2000 rpm	0000527500	EUR 156,00

* (PTFE-coated)

NANO-STAR 7.5 digital	MICRO-STARS digital control	MINI-STARS digital control	EUROSTAR 20 40 digital	EUROSTAR 60 digital control	EUROSTAR 100 digital control	EUROSTAR 200 digital control	EUROSTAR 400 digital control	EUROSTAR 100 & 200 P4 control	RW 20 digital	RW 28 digital	RW 47 digital
++	++	++	++	++	++	++	++	++	++	++	-
-	-	-	-	++	++	++	++	++	-	++	++
-	-	-	-	-	-	-	++	-	-	-	++
++	++	++	++	++	++	++	++	++	++	++	-
++	++	++	++	++	++	++	++	++	++	++	-
-	-	-	-	-	-	++	++	++	-	++	++
-	-	-	-	-	-	++	++	-	-	++	++
++	++	++	++	++	++	++	++	++	++	++	-
++	++	++	++	++	++	++	++	++	++	++	-
-	-	-	-	++	++	++	++	++	-	++	++
-	-	-	-	++	++	++	++	++	-	++	++
++	++	++	++	++	++	++	++	++	++	++	-
-	-	-	-	++	++	++	++	++	-	++	++
++	++	++	++	++	++	++	++	++	++	++	-
+	+	+	+	++	++	++	++	++	-	++	-
-	-	-	-	-	-	++	++	++	-	++	++
-	-	-	-	-	-	-	++	-	-	-	++
++	++	++	++	++	++	++	++	++	++	-	-
-	-	-	-	++	++	++	++	++	-	++	-
-	-	-	-	-	-	++	++	++	-	++	++
-	-	-	++	++	++	++	++	++	++	++	++
-	-	-	++	++	++	++	++	++	++	++	++
+	+	+	++	++	++	++	++	++	++	++	++
-	-	-	++	++	++	++	++	++	++	++	++
-	-	-	-	-	+	+	++	-	-	++	++
++	++	++	++	++	++	++	++	++	++	++	++
-	-	-	++	++	++	++	++	++	++	++	++
-	-	-	++	++	++	++	++	-	++	++	++
++	++	++	++	+	+	+	+	+	++	-	-
++	++	++	++	+	+	+	+	+	++	-	-

++ IKA recommended | + Installable | - Not compatible

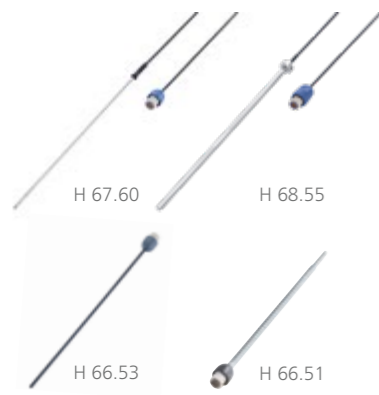

Product	Ident. No.	Price	NANOSTAR digital	MICRO-STARS digital control	MINISTARS digital control
TEMPERATURE SENSORS					
H 67.60 stainless steel	0025006664	EUR 170,00	-	control	control
H 67.61 stainless steel	0025007920	EUR 247,00	-	control	control
H 68.55 stainless steel	0025007921	EUR 320,00	-	control	control
H 70 extension cable	0002735600	EUR 231,00	-	control	control
SENSORS IN COMBINATION WITH H 70					
H 62.51 stainless steel	0002735451	EUR 228,00	-	control	control
H 66.51 glass-coated	0002735551	EUR 333,00	-	control	control
H 66.53 coated	0004499900	EUR 267,00	-	control	control
STANDS					
Plate stands					
IKA [scale]	0025004318	EUR 934,00	++	++	++
R 1825	0003160000	EUR 331,00	++	++	++
R 1826	0003160100	EUR 365,00	++	++	++
R 1827	0003160200	EUR 389,00	++	++	++
H-stand					
R 2722	0001412000	EUR 794,00	-	++	++
Telescopic stands					
R 2723	0001412100	EUR 1.473,00	-	++	++
R 474	0001643000	EUR 2.074,00	-	-	-
Floor stands					
R 472	0000738700	EUR 4.407,00	-	-	-
R 2850	0020002900	EUR 3.241,00	-	-	-
R 6547 H	0020018533	EUR 10.479,00	-	-	-
R 6547 E 400V	0020018673	EUR 15.683,00	-	-	-



IKA [scale]



CLAMPS // Compatibility with stands (++ / -)					
Product	R 182	R 270	R 271	RH 3	RH 5
IKA [scale]	++	-	-	++	-
R 1825	++	-	-	++	-
R 1826	++	-	-	++	-
R 1827	++	-	-	++	-
R 2722	-	++	++	-	++
R 2723	-	++	++	-	++

EUROSTAR 20 40 digital	EUROSTAR 60 digital control	EUROSTAR 100 digital control	EUROSTAR 200 digital control	EUROSTAR 400 digital control	EUROSTAR 100 & 200 P4 control	EUROSTAR 20 high speed digital control	RW 20 digital	RW 28 digital	RW 47 digital
-	control	control	control	control	++	control	-	-	-
-	control	control	control	control	++	control	-	-	-
-	control	control	control	control	++	control	-	-	-
-	control	control	control	control	++	control	-	-	-
-	control	control	control	control	++	control	-	-	-
++	+	-	-	-	-	-	++	-	-
++	+	+	-	-	-	-	++	-	-
++	+	+	-	-	-	-	++	-	-
++	+	+	-	-	-	-	++	-	-
++	++	++	++	++	++	++	++	++	-
++	++	++	++	++	++	++	++	++	-
-	-	-	-	-	-	-	-	-	++
-	-	++	++	++	++	-	-	++	-
-	-	-	-	-	-	-	-	-	++
-	-	-	-	-	-	-	-	-	++

++ IKA recommended | + Installable | - Not compatible



R 1825

IKA [scale]

R 2723

R 6547 H



R 1401

R 1402



R 301



R 60



LABORATORY SOFTWARE

labworldsoft® 6 Starter

EUR 5.065,00

Ident. No. 0020019397

labworldsoft® 6 Advanced

EUR 8.809,00

Ident. No. 0020105873

labworldsoft® 6 Pro

EUR 11.537,00

Ident. No. 0020017366

labworldsoft® is a laboratory software to control lab devices, automate processes, and to document your measurements and results. The software provides access to a huge library of different laboratory devices. labworldsoft® does not integrate only IKA laboratory devices, but supports several other devices from different manufacturers as well. You stay flexible in the choice of your lab devices you want to use and profit from the whole device range of the laboratory world.

Product	Description	Ident. No.	Price
ACCESSORIES EUROSTAR 20 HIGH SPEED DIGITAL AND CONTROL			
R 1401	Propeller, Ø 55 mm	0001242900	EUR 299,00
R 1405	Propeller, Ø 45 mm	0001289800	EUR 241,00
R 1402	Dissolver, Ø 42 mm	0001243300	EUR 333,00
ACCESSORIES FOR PROTECTION AND SAFETY			
R 301	Stirring shaft protection	0002603000	EUR 208,00
R 301.1	Support holder for R 301	0002604000	EUR 247,00
R 303	Stirring shaft protection	0030000257	EUR 494,00
SI 400	Safety switch	0003294800	EUR 1.090,00
SI 472	Fixing device for SI 400 to R 472 stand	0003264000	EUR 1.024,00
SI 474	Fixing device for SI 400 to R 474 or T 653 stand	0003264400	EUR 467,00
FURTHER ACCESSORIES			
WH 11	Wall mount for WiCo	0025001500	EUR 34,00
FK 1	Flexible coupling	0002336000	EUR 351,00
R 60	Keyless chuck	0003889500	EUR 92,50
R 60.1	Keyless chuck	0025007821	EUR 92,50

**SAFETY FIRST**

Stress-free mixing at your own convenience with increased productivity, flexibility and enhanced safety features. A safety stop function allows for example the quick stop of the overhead stirrer. Stirring shaft protection, which is available as an accessory, prevents potential injuries due to the rotating shafts and stirring elements. The clear display of the control versions shows all relevant values such as torque and speed as well as PC connectivity if the device is controlled with labworldsoft®. This ensures a constant overview of the stirring process.

Mixing, heating, cooling – It's no longer a question of "either/or". The powerful MATRIX thermoshakers can do everything you need. You can achieve optimal mixing results with the smallest of volumes, whether it's blood samples, pharmaceutical agents, DNA / RNA samples or ELISA assays. In combination with IKA incubation shakers, centrifuges, pipettes and the Dry Block Heater, our thermoshakers facilitate an optimum workflow in the field of Sample Handling, Liquid Handling and Cell Handling.

MATRIX ORBITAL DELTA PLUS

/// The thermoshaker with cooling feature

The MATRIX Orbital Delta Plus is the youngest member of the MATRIX family. This thermoshaker mixes, heats and cools samples in the milliliter range. This simultaneity ensures particularly good mixing and shorter reaction times. A speed range of up to 3000 rpm and a 3 mm shaking stroke contribute to controlled, rapid and even mixing to the most challenging samples.



▶ Watch MATRIX video

SIMPLY USER-FRIENDLY

There are numerous attachments available for the MATRIX Orbital Delta Plus, all of which can be changed quickly and easily. The special attachment fixing system improves temperature transfer and the outer plastic casing ensures that the users don't burn their fingers.

ACCESSORIES FOR LIFE SCIENCE APPLICATIONS

All of the equipment in the IKA MATRIX range can be combined with the most varied of micro-titration plates, deep well plates, Eppendorf reaction vessels, PCR strips, Greiner tubes, micro-plates and cuvettes. The IKA thermocover prevents the formation of condensation on the vessel cover, meaning that the sample remains constant.

AWARD-WINNING DESIGN

The MATRIX Orbital Delta Plus has been awarded the coveted German Design Award 2021. That's because it is designed to sit on a sturdy mount, even with its minimal footprint. Its clear shape, smooth surface and inventive layout not only make this thermoshaker look good, but also makes it easier to use – as per the well-known IKA menu navigation.



MATRIX Orbital

EUR 1.748,00

Ident. No. 0030000627



Mixing

① **MATRIX Orbital Δ FP**

EUR 2.414,00

Ident. No. 0030000751

② **MATRIX Orbital Δ F0.5**

EUR 2.414,00

Ident. No. 0030000747

③ **MATRIX Orbital Δ F1.5**

EUR 2.414,00

Ident. No. 0030000750

④ **MATRIX Orbital Δ F2.0**

EUR 2.414,00

Ident. No. 0030000753

Mixing & heating



TECHNICAL DATA

	MATRIX ORBITAL	MATRIX ORBITAL Δ FP F0.5 F1.5 F2.0
Type of movement	Orbital	Orbital
Speed range	300 – 3000 rpm	FP F0.5: 300 – 2000 rpm F1.5 F2.0: 300 – 1500 rpm
Shaking stroke	3 mm	3 mm
Heating range	–	RT + 4 °C – 100 °C
Permissible shaking weight (incl. attachment)	0.3 kg	0.3 kg
Operating mode	Timer and continuous operation	Timer and continuous operation
Dimensions (W × H × D)	198 × 124 × 318 mm	FP: 216 × 147 × 351 mm F0.5: 216 × 149 × 351 mm F1.5 / 2.0: 216 × 158 × 351 mm
Protection class according to DIN EN 60529	IP 21	IP 21

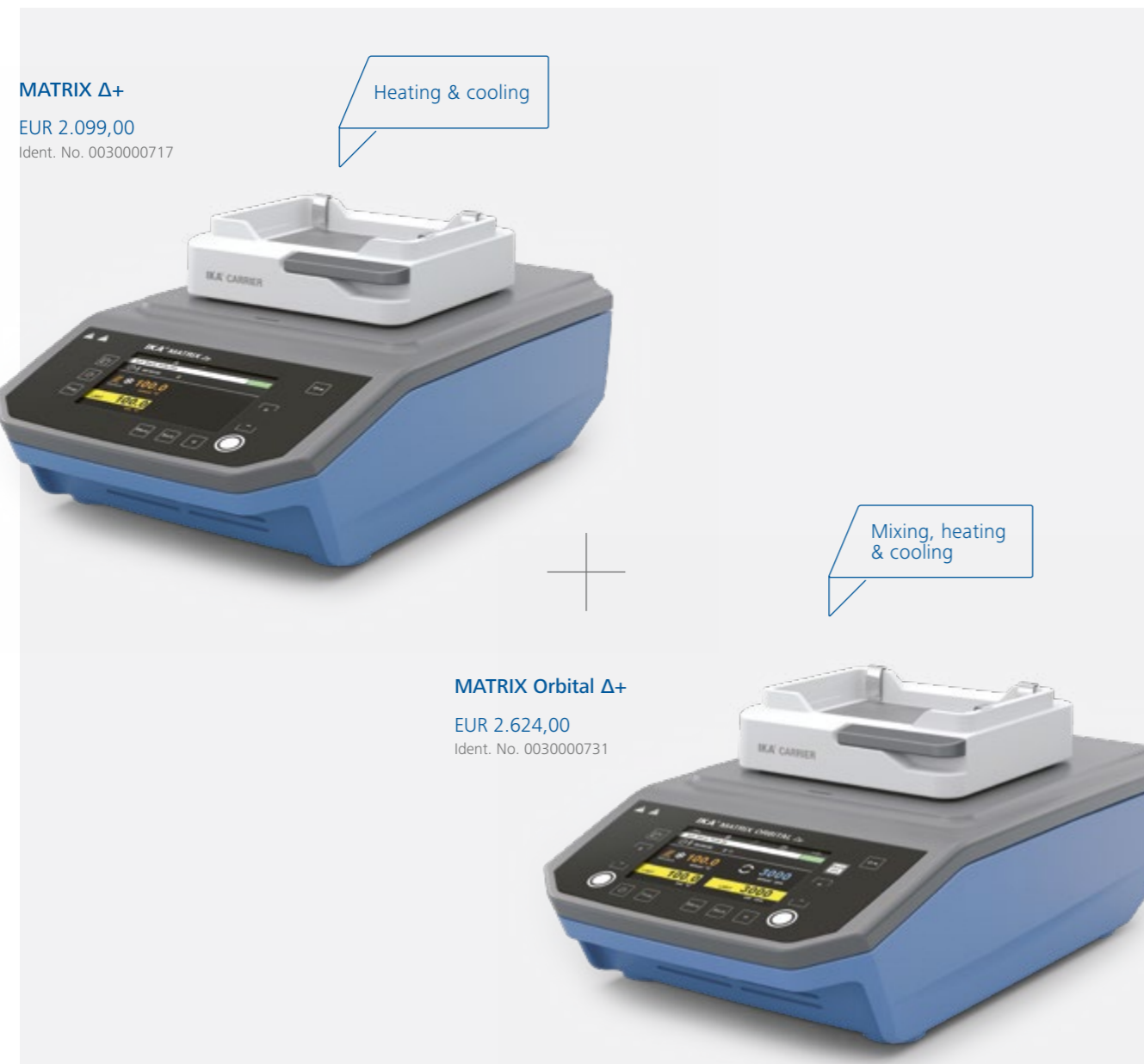

MATRIX Δ+
EUR 2.099,00
Ident. No. 0030000717

MATRIX Orbital Δ+
EUR 2.624,00
Ident. No. 0030000731

TECHNICAL DATA	MATRIX Δ+	MATRIX ORBITAL Δ+
Type of movement	–	Orbital
Speed range	–	300 – 3000 rpm
Shaking stroke	–	3 mm
Heating range	RT -30 °C – 110 °C	RT -15 °C – 100 °C
Permissible shaking weight (incl. attachment)	0.3 kg	0.3 kg
Operating mode	Timer and continuous operation	Timer and continuous operation
Dimensions (W x H x D)	216 x 127 x 351 mm	216 x 127 x 351 mm
Protection class according to DIN EN 60529	IP 21	IP 21

Product	Description	Ident. No.	Price	
ACCESSORIES THERMOSHAKERS				
(A)	MX cover	Cover	0030001253	EUR 112,00
(B)	MX thermocover	Cover, heatable	0030001244	EUR 524,00
(C)	MX 50.0 ml	Attachment for vials, 4 x 50 ml vials	0030000863	EUR 524,00
(D)	MX 15.0 ml	Attachment for vials, 8 x 15 ml vials	0030000821	EUR 561,00
(E)	MX 5.0 ml	Attachment for vials, 8 x 5 ml vials	0030000859	EUR 561,00
(F)	MX 2.0 ml	Attachment for vials, 24 x 2.0 ml vials	0030000834	EUR 524,00
(G)	MX 1.5 ml	Attachment for vials, 24 x 1.5 ml vials	0030000829	EUR 524,00
(H)	MX 12.0 mm	Attachment for vials, 24 x 12 mm vials	0030000844	EUR 561,00
(I)	MX cryo	Attachment for vials, 24 x cryo vials	0030000848	EUR 561,00
(J)	MX 0.5 ml	Attachment for vials, 24 x 0.5 ml vials	0030000840	EUR 561,00
(K)	MX PCR96	Attachment for 96 PCR plates	0030000853	EUR 629,00
(L)	MX PCR384	Attachment for 384 PCR plates	0030000857	EUR 674,00
(M)	MX carrier	Attachment for microtiter plates	0030000849	EUR 629,00
(3)	MX insert 1.5/2.0 ml	Insert for 1.5 / 2.0 ml vials	0030001158	EUR 44,50
(2)	MX insert 0.5 ml	Insert for 0.5 ml vials	0030001157	EUR 44,50
(1)	MX insert PCR96	Insert for 0.2 ml PCR vials	0030001159	EUR 44,50



Shaken, not stirred. At IKA, experience and passion for the laboratory shaker go back nearly 100 years. Today we cover the entire range of motion in mixing technology. In combination with innovative automation, high-quality materials and ergonomic design, people rock, roll, turn and shake with us.

KS 3000 IC CONTROL

/// Incubator shaker

The KS 3000 ic control is a universal benchtop incubation shaker. It mixes and incubates, making it ideal for cultivating cells, bacterial suspensions, hybridization, staining and decolorizing, and metabolic studies. In addition to experiments with biological cultures, it is also ideal for solubility studies, extraction processes and general mixing processes.



VERSATILE – THANKS TO ITS MANY ACCESSORIES

Under its hood, the KS 3000 ic control offers you a world of options: Countless attachments, flasks, bowls and vessels make this simple device so versatile and make it stand out among incubation shakers.

HEAVY SHAKING WEIGHT

With a shaking weight of 7.5 kg, which is a lot for its compact size, the KS 3000 ic control is an extremely powerful laboratory shaker.

TEMPERATURE CONTROL WITHIN THE MEDIUM

KS 3000 ic control not only has a heat exchanger, it also has a sensor in the medium. This allows the temperature to be set directly within the sample.

① KS 3000 i control

EUR 6.357,00
Ident. No. 0003940000

② KS 3000 ic control

EUR 7.266,00
Ident. No. 0003940100



KS 3000 ic with built-in cooling coil

②

Allows unattended operation

① KS 4000 i control

EUR 7.693,00
Ident. No. 0003510000

② KS 4000 ic control

EUR 8.539,00
Ident. No. 0003510100



①

TECHNICAL DATA	KS 3000 I IC	KS 4000 I IC
Type of movement	Orbital	Orbital
Permissible shaking weight (incl. attachment)	7.5 kg	20 kg
Speed range	10 – 500 rpm	10 – 500 rpm
Timer display	7 segment LED	7 segment LED
Speed display	LED	LED
Operating mode	Timer and continuous operation	Timer and continuous operation
Temperature range (inlet T>3°C)	RT +5 °C – 80 °C RT -10 °C – 80 °C	RT +5 °C – 80 °C RT -10 °C – 80 °C
Total volume inner chamber	50 l	90 l
Dimensions (W x H x D)	465 x 430 x 695 mm	580 x 525 x 750 mm
Protection class according to DIN EN 60529	IP 30	IP 30

① **ROCKER 2D basic**

EUR 1.037,00
Ident. No. 0004002000

② **ROCKER 2D digital**

EUR 1.103,00
Ident. No. 0004003000



① **ROCKER 3D basic**

EUR 1.103,00
Ident. No. 0004000000

② **ROCKER 3D digital**

EUR 1.166,00
Ident. No. 0004001000



① **ROLLER 6 basic**

EUR 1.751,00
Ident. No. 0004010000

② **ROLLER 6 digital**

EUR 1.815,00
Ident. No. 0004011000



① **ROLLER 10 basic**

EUR 2.139,00
Ident. No. 0004012000

② **ROLLER 10 digital**

EUR 2.203,00
Ident. No. 0004013000



TECHNICAL DATA	ROCKER 2D BASIC DIGITAL	ROCKER 3D BASIC DIGITAL	ROLLER 6 BASIC DIGITAL	ROLLER 10 BASIC DIGITAL
Type of movement	Rocking	Tumbling	Rocking and rolling	Rocking and rolling
Speed range	0 – 80 rpm	30 rpm 0 – 80 rpm	30 rpm 0 – 80 rpm	30 rpm 0 – 80 rpm
Timer display	– 7 segment LED	– 7 segment LED	– 7 segment LED	– 7 segment LED
Speed display	– 7 segment LED	– 7 segment LED	– 7 segment LED	– 7 segment LED
Operating mode	Continuous operation Timer and continuous operation	Continuous operation Timer and continuous operation	Continuous operation Timer and continuous operation	Continuous operation Timer and continuous operation
Dimensions (W x H x D)	280 x 150 x 330 mm	280 x 165 x 330 mm 280 x 185 x 330 mm	240 x 115 x 545 mm	380 x 115 x 545 mm
Protection class according to DIN EN 60529	IP 21	IP 21	IP 21	IP 21

① **Loopster basic**

EUR 934,00
Ident. No. 0004015000

② **Loopster digital**

EUR 1.002,00
Ident. No. 0004016000



① **Trayster basic**

EUR 1.037,00
Ident. No. 0004005000

② **Trayster digital**

EUR 1.103,00
Ident. No. 0004006000

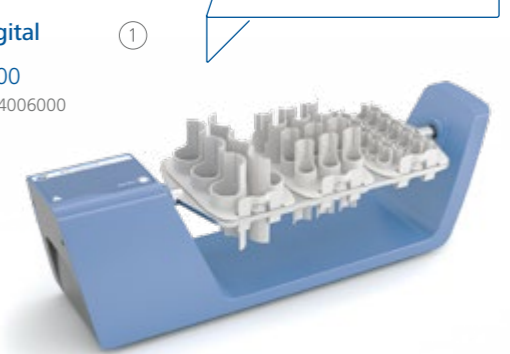

① **Hula Dancer basic**

EUR 359,00
Ident. No. 0025004320

② **Hula Dancer digital**

EUR 419,00
Ident. No. 0025003634



① **MS 3 basic**

EUR 679,00
Ident. No. 0003617000

② **MS 3 digital**

EUR 974,00
Ident. No. 0003319000

③ **MS 3 control**

EUR 1.037,00
Ident. No. 0020016017



TECHNICAL DATA	LOOPSTER BASIC DIGITAL	TRAYSTER BASIC DIGITAL	HULA DANCER BASIC DIGITAL	MS 3 BASIC DIGITAL CONTROL
Type of movement	Rotating	Overhead	Orbital	Orbital
Permissible shaking weight (incl. attachment)	2 kg	2 kg	0.1 kg	0.5 kg
Speed range	20 rpm 0 – 80 rpm	20 rpm 0 – 80 rpm	2800 rpm 1200 – 2800 rpm	200 – 3000 rpm 200 – 3000 rpm 100 – 3000 rpm
Timer display	– 7 Segment LED	– 7 Segment LED	– –	– 7 Segment LED LCD
Operating mode	Continuous operation Timer and continuous operation	Continuous operation Timer and continuous operation	–	Continuous operation Timer and continuous operation Timer and continuous operation
Dimensions (W x H x D)	300 x 360 x 300 mm	460 x 180 x 140 mm	123 x 42 x 123 mm	148 x 63 x 205 mm
Protection class according to DIN EN 60529	IP 21	IP 21	IP 42	IP 21

VORTEX 2

EUR 293,00

Ident. No. 0025000258

**VORTEX 3**

EUR 480,00

Ident. No. 0003340000

**HANDS FOR CHILDREN**

The aid project HANDS FOR CHILDREN was created in 2000 by IKA owner and Managing Director René Stiegelmann. In the context of this voluntary initiative, retired IKA employees assemble laboratory equipment free-of-charge, so that the proceeds can be used for children's charity programs. More than 2000 voluntary hours per year are used for the benefit of medical care for disabled children in Uganda and for schooling programs in Tanzania, for example.

TECHNICAL DATA	VORTEX 2	VORTEX 3
Type of movement	Orbital	Orbital
Speed range	500 – 2500 rpm	0 – 2500 rpm
Timer	No	No
Speed display	Scale	Scale (0-6)
Operating mode	Continuous / touch operation	Continuous / touch operation
Permissible shaking weight (incl. attachment)	0.4 kg	0.4 kg
Dimensions (W x H x D)	120 x 140 x 138 mm	127 x 136 x 149 mm
Protection class according to DIN EN 60529	IP 21	IP 21

VORTEX 1

EUR 389,00

Ident. No. 0004047700

**VXR basic Vibrax®**

EUR 1.880,00

Ident. No. 0002819000

**MTS 2/4 digital**

EUR 2.003,00

Ident. No. 0003208000

For shaking two or four microtiter plates

**lab dancer**

EUR 247,00

Ident. No. 0003365000



TECHNICAL DATA	VORTEX 1	VXR BASIC VIBRAX®	MTS 2/4 DIGITAL	LAB DANCER
Type of movement	Orbital	Orbital	Orbital	Orbital
Speed range	1000 – 2800 rpm	100 – 2200 rpm	50 – 1100 rpm	2800 rpm
Timer	–	–	Yes	–
Speed display	–	Scale	Scale	–
Operating mode	Touch operation	Continuous operation	Timer and continuous operation	Touch operation
Permissible shaking weight (incl. attachment)	0.1 kg	2 kg	1 kg; 2/4 MT-plates	0.1 kg
Dimensions (W x H x D)	95 x 70 x 110 mm	157 x 130 x 247 mm	185 x 105 x 320 mm	100 x 70 x 100 mm
Protection class according to DIN EN 60529	IP 40	IP 21	IP 21	IP 40

① KS 130 basic

EUR 1.852,00
Ident. No. 0002980000

② KS 130 control

EUR 2.715,00
Ident. No. 0002980100

③ KS 130 control NOL

EUR 2.715,00
Ident. No. 0004278200



① KS 260 basic

EUR 2.962,00
Ident. No. 0002980200

② KS 260 control

EUR 3.703,00
Ident. No. 0002980300

③ KS 260 control NOL

EUR 3.703,00
Ident. No. 0004278400



TECHNICAL DATA	KS 130 BASIC CONTROL	KS 260 BASIC CONTROL
Type of movement	Orbital	Orbital
Shaker diameter	4 mm	10 mm
Permissible shaking weight (incl. attachment)	2.0 kg	7.5 kg
Speed range	80 – 800 rpm	50 – 500 rpm 10 – 500 rpm
Timer display	LED line LCD	LED line LCD
Speed display	LED line LCD	LED line LCD
Operating mode	Timer and continuous operation	Timer and continuous operation
Dimensions (W × H × D)	270 × 98 × 316 mm	360 × 98 × 420 mm
Protection class according to DIN EN 60529	IP 21	IP 21

① HS 260 basic

EUR 2.962,00
Ident. No. 0003066600

② HS 260 control

EUR 3.703,00
Ident. No. 0003066700

③ HS 260 control NOL

EUR 3.703,00
Ident. No. 0004278600



① HS 501 digital

EUR 5.493,00
Ident. No. 0025002982

② KS 501 digital

EUR 5.493,00
Ident. No. 0025002985

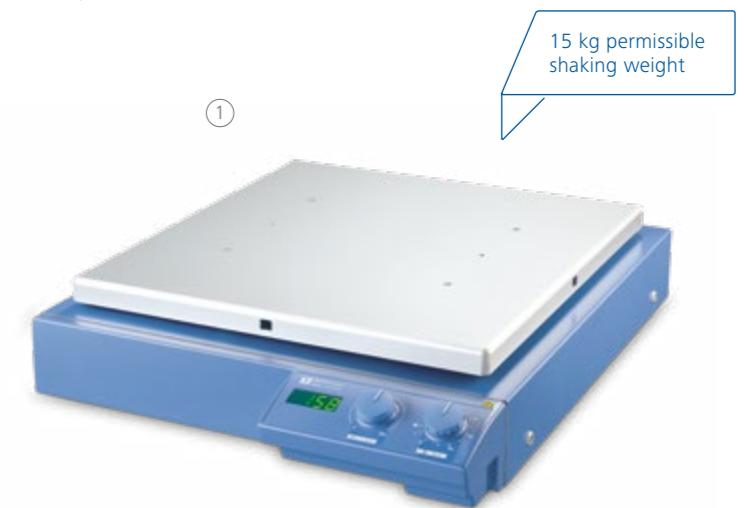

TECHNICAL DATA	HS 260 BASIC CONTROL	HS 501 DIGITAL KS 501 DIGITAL
Type of movement	Reciprocating	Reciprocating Orbital
Shaker diameter	20 mm	30 mm
Permissible shaking weight (incl. attachment)	7.5 kg	15 kg
Speed range	20 – 300 rpm 10 – 300 rpm	0 – 300 rpm
Timer display	LED line LCD	Scale
Speed display	LED line LCD	7 segment LED
Operating mode	Timer and continuous operation	Timer and continuous operation
Dimensions (W × H × D)	360 × 100 × 420 mm	505 × 120 × 585 mm
Protection class according to DIN EN 60529	IP 21	IP 21



RD 1



TB 1

TB 3

Product	Description	Ident. No.	Price
---------	-------------	------------	-------

ACCESSORIES ROCKER

A 2	Second level attachment	0004581700	EUR 82,00
RD 1	Universal mat	0004532000	EUR 26,50
RD 2	Burled mat	0004532100	EUR 28,50
TB 1	Tray, 24 x 5 ml, Ø 12 mm	0004532200	EUR 45,50
TB 2	Tray, 12 x 15 ml, Ø 16 mm	0004532300	EUR 45,50
TB 3	Tray, 10 x 30 ml, Ø 25 mm	0004532400	EUR 45,50
TB 4	Tray, 8 x 30 ml, Ø 28 mm	0004532500	EUR 45,50

ACCESSORIES LOOPSTER

DS 1	Tube attachment, 48 x 1.5 ml, Ø 10 mm	0004524000	EUR 243,00
DS 2	Tube attachment, 24 x 5 ml, Ø 12 mm	0004524100	EUR 174,00
DS 3	Tube attachment, 20 x 15 ml, Ø 16 mm	0004524200	EUR 174,00
DS 4	Tube attachment, 2 x 30 ml, Ø 25 mm	0004524300	EUR 174,00
DS 5	Tube attachment, 12 x 50 ml, Ø 28 mm	0004524400	EUR 174,00
DS 6	Universal disc	0004524500	EUR 150,00
DS 6.1	Spare clips, Ø 10 mm, 12 pcs.	0004524600	EUR 45,50
DS 6.2	Spare clips, Ø 12 mm, 12 pcs.	0004524700	EUR 45,50
DS 6.3	Spare clips, Ø 16 mm, 12 pcs.	0004524800	EUR 45,50
DS 6.4	Spare clips, Ø 25 mm, 12 pcs.	0004524900	EUR 45,50
DS 6.5	Spare clips, Ø 28 mm, 12 pcs.	0004525000	EUR 45,50

ACCESSORIES TRAYSTER

TR 1	Tube insert, 24 x 1.5 ml, Ø 10 mm	0004525100	EUR 54,00
TR 2	Tube insert, 24 x 5 ml, Ø 12 mm	0004525200	EUR 54,00
TR 3	Tube insert, 12 x 15 ml, Ø 16 mm	0004525300	EUR 54,00
TR 4	Tube insert, 6 x 50 ml, Ø 28 mm	0004525400	EUR 54,00



DS 2
Tube attachment



DS 4
Tube attachment



DS 6.1



DS 6.2



DS 6.3



DS 6.4



TR 1



TR 2



TR 3



TR 4



MS 1.33

MS 1.32

MS 1.31

MS 3.5

MS 3.3

MS 3.1

Product	Description	Ident. No.	Price
---------	-------------	------------	-------

ACCESSORIES MS 3 BASIC | DIGITAL | CONTROL

MS 3.1	Standard attachment	0003426300	EUR 20,50
MS 3.3	Universal attachment	0003426600	EUR 20,50
MS 1.21	One-hand insert	L001540	EUR 29,50
MS 1.30	Attachment for 0.5 ml tubes	0025005776	EUR 62,00
MS 1.31	Test tube insert, 14 x Ø 10 mm	L001840	EUR 64,50
MS 1.32	Test tube insert, 6 x Ø 12 mm	L001850	EUR 64,50
MS 1.33	Test tube insert, 4 x Ø 16 mm	L001860	EUR 64,50
MS 1.34	Test tube insert	L001830	EUR 31,50
MS 3.4	Microtiter plate attachment	0003426400	EUR 64,50
MS 3.5	PCR plate attachment, 96-well	0003428000	EUR 64,50

ACCESSORIES VORTEX 2 | VORTEX 3

VG 3.1	Standard attachment	0003341200	EUR 14,00
VG 3.2	One-hand attachment	0003342300	EUR 29,50
VG 3.21	Rubber mat	0020008398	EUR 26,50
VG 3.3	Universal attachment, 150 mm	0003342400	EUR 33,00
VG 3.30	Attachment for PCR-tubes, 0.2 ml	0025005779	EUR 41,00
VG 3.31	Test tube attachment for 54 Eppendorf tubes	0003344300	EUR 77,00
VG 3.32	Test tube attachment, 18 x Ø 10 mm	0003343900	EUR 41,00
VG 3.33	Test tube attachment, 12 x Ø 12 mm	0003344000	EUR 41,00
VG 3.34	Test tube attachment, 8 x Ø 16 mm	0003344100	EUR 41,00
VG 3.35	Test tube attachment, 8 x Ø 20 mm	0003344200	EUR 41,00
VG 3.36	Erlenmeyer flask attachment, 100 – 250 ml	0003342100	EUR 41,00
VG 3.37	Microtiter plate attachment	0003344400	EUR 41,00

VG 3.35

VG 3.34

VG 3.32

VG 3.31

VG 3.1

VG 3.3

Product	Description	Ident. No.	Price
ACCESSORIES VXR			
VX 1	One-hand attachment, 1 – 250 ml	0000607200	EUR 121,00
VX 2	Test tube attachment, 36 × Ø 16 mm	0000568900	EUR 495,00
VX 2E.n	Suitable for Eppendorf Tubes®, 64 × 1.5 ml	0020018016	EUR 480,00
VX 7	Dish attachment	0000953300	EUR 350,00
VX 8	Universal attachment	0000910400	EUR 839,00
VX 11	Basic holder	0003627700	EUR 183,00
VX 11.1	Test tube insert, 70 × Ø 10 mm	0003659000	EUR 183,00
VX 11.2	Test tube insert, 41 × Ø 12 mm	0003659100	EUR 183,00
VX 11.3	Test tube insert, 32 × Ø 16 mm	0003659200	EUR 140,00
VX 11.4	Test tube insert, 18 × Ø 20 mm	0003659300	EUR 140,00
VX 11.5	Attachment for 30 ml tubes, 12 × Ø 23 mm	0025005778	EUR 125,00
VX 11.6	Attachment for 50 ml tubes, 8 × Ø 27 mm	0025005777	EUR 125,00
VX 8.1	Clamping roll	0003375400	EUR 47,50

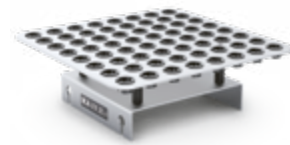

VX 2E.n



VX 2



VX 11.1

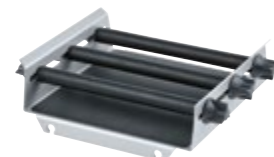

AS 130.1



AS 260.3



AS 1.10



AS 501.2



AS 501.3



AS 501.6

Product	Description	Ident. No.	Price
ACCESSORIES KS 130 BASIC CONTROL			
AS 130.1	Universal attachment	0008017300	EUR 419,00
AS 130.2	Fixing clip attachment	0003115000	EUR 126,00
AS 130.3	Dish attachment	0003120000	EUR 121,00
AS 130.4	Test tube attachment	0003120300	EUR 283,00

Product	Description	Ident. No.	Price
ACCESSORIES KS HS 260 BASIC CONTROL AND KS 3000			
AS 260.1	Universal attachment	0008017400	EUR 700,00
AS 260.2	Fixing clip attachment	0003115500	EUR 182,00
AS 260.3	Dish attachment	0003120600	EUR 153,00
AS 260.5	Separating funnel attachment	0003120900	EUR 729,00

Product	Description	Ident. No.	Price
ACCESSORIES KS HS 501 DIGITAL			
AS 501.1	Universal attachment	0008000200	EUR 2.102,00
AS 501.2	Separating funnel attachment	0008000300	EUR 2.241,00
AS 501.3	Separating funnel attachment	0008000400	EUR 1.821,00
AS 501.4	Fixing clip attachment	0002341100	EUR 1.399,00
AS 501.5	Dish attachment	0002339600	EUR 281,00
AS 501.6	Separating funnel attachment	0008000500	EUR 3.223,00



AS 1.400



AS 4000.1



AS 1.30



AS 1.31



AS 1.7



AS 1.13



AS 2.1



AS 2.4



AS 2.6

Product	Description	Ident. No.	Price
ACCESSORIES KS 4000 IC CONTROL			
AS 4000.1	Universal attachment	0008022200	EUR 1.117,00
AS 4000.2	Fixing clip attachment	0003710100	EUR 933,00
AS 4000.3	Dish attachment	0003710000	EUR 245,00
AS 1.400	Basic holder for AS 4000.1	0003710200	EUR 640,00
AS 1.401	Clamping roll for AS 4000.1	0003712000	EUR 63,00
AS 1.402	Fastening screw for AS 4000.1	0003712300	EUR 10,20

Product	Description	Ident. No.	Price
ACCESSORIES			
AS 1.30	Basic holder for AS 130.1	0003148000	EUR 355,00
AS 1.60	Basic holder for AS 260.1	0003149000	EUR 640,00
AS 1.10	Basic holder for AS 501.1	0002339700	EUR 947,00
AS 1.31	Clamping roll for AS 130.1	0003030500	EUR 39,00
AS 1.61	Clamping roll for AS 260.1	0003030501	EUR 48,50
AS 1.11	Clamping roll for AS 501.1	0002339800	EUR 88,50
AS 1.6	Clamping device for AS 501.1	0001268400	EUR 62,00
AS 1.7	Clamping device for AS 501.1	0001269200	EUR 86,50
AS 1.12	Supporting bar for AS 1.10	0002594500	EUR 176,00
AS 1.13	Ground section holder for AS 1.10	0002597000	EUR 171,00
STICKMAX	Universal adhesive mat	0003920000	EUR 65,50
AS 2.0	Fixing clips, 10 ml	0020016475	EUR 59,00
AS 2.1	Fixing clips, 25 ml	0001234300	EUR 31,50
AS 2.2	Fixing clips, 50 ml	0001234400	EUR 31,50
AS 2.3	Fixing clips, 100 ml	0001234500	EUR 31,50
AS 2.4	Fixing clips, 200 250 ml	0001234600	EUR 59,00
AS 2.5	Fixing clips, 500 ml	0001234700	EUR 59,00
AS 2.6	Fixing clips, 1000 ml	0003819300	EUR 59,00
AS 2.7	Fixing clips, 2000 ml	0020016476	EUR 83,00



STICKMAX

IKA's ULTRA-TURRAX® – used for homogenizing, emulsifying or suspending. The digital display allows you to keep track of the speed and the development of the products focused on a soft start of the motor. There is a broad spectrum of dispersing tools to choose from. Common disperser applications include: homogenization of effluent samples, dispersing tasks under vacuum pressure, and PCR analysis.

T 25 EASY CLEAN DIGITAL AND CONTROL ULTRA-TURRAX®

/// The new dispersing experience

More quiet, clean and even remote controlled: The T 25 easy clean high-performance disperser in the digital and control versions will change your dispersing experience. These instruments hit the spot with electronic speed control from 3000 – 25 000 rpm, a digital timer setting, a working volume of 1 – 2000 ml (water), a long service life both for the drive and tools, as well as a wide range of dispersing tools to choose from. Medical samples are perfectly homogenized, cosmetics emulsified and paints suspended in a short time, due to the high speed and high shear operation.



ELECTRONICALLY COMMUTATED MOTOR

IKA applies a new motor technology to the devices in the T 25 easy clean series: The brushless DC motor, with a noise level of 70 dB, ensures a significant noise reduction in the lab. It also allows carbon dust-free operation.

EASY CLEANING

Easy clean means: The dispersing element is easily cleaned without disassembly, thanks to its manually extendable rotor. The tool is also dishwasher-compatible and completely autoclavable.

INTEGRATED TEMPERATURE MEASUREMENT

Yet another highlight is the patented, integrated temperature measurement in the T 25 easy clean control version. The temperature sensor is integrated into the tool and thus enables the permanent monitoring of the medium temperature. Combined with the safety temperature setting, this helps to protect temperature-sensitive samples.

T 18 brushless digital ULTRA-TURRAX®

EUR 1.853,00
Ident. No. 0020102476

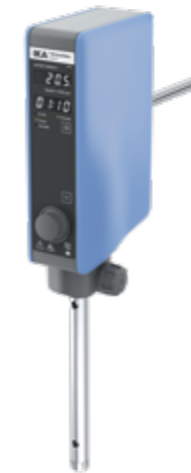

Brushless DC motor guarantees dust-free and quieter operation

T 25 easy clean digital ULTRA-TURRAX®

EUR 2.494,00
Ident. No. 0025002560



T 25 easy clean control ULTRA-TURRAX®

EUR 3.071,00
Ident. No. 0025002500



T 65 digital ULTRA-TURRAX®

EUR 9.491,00
Ident. No. 0004234500



UTL 25 digital Inline ULTRA-TURRAX®

EUR 11.328,00
Ident. No. 0010006856



TECHNICAL DATA

TECHNICAL DATA	T 18 BRUSHLESS DIGITAL	T 25 EASY CLEAN DIGITAL CONTROL	T 65 DIGITAL ULTRA-TURRAX®	UTL 25 DIGITAL ULTRA-TURRAX®
Process type	Batch	Batch	Batch	Inline
Speed range	3000 – 25 000 rpm	3000 – 25 000 rpm	1000 – 9500 rpm	3000 – 25 000 rpm
Volume range (H ₂ O)	0.001 – 1.5 l	0.001 – 2.0 l	2 – 50 l	–
Speed control	Stepless	Stepless	Stepless	Stepless
Noise without element	70 dB(A)	70 dB(A)	75 dB(A)	73 dB(A)
Extension arm length	160 mm	160 mm	–	175 mm
Viscosity max.	5000 mPas	5000 mPas	5000 mPas	–
Dimensions (W × H × D)	89 × 270 × 161 mm	89 × 270 × 161 mm	300 × 420 × 400 mm	450 × 120 × 100 mm
Protection class according to DIN EN 60529	IP 30	IP 30	IP 54	IP 54

T 10 basic ULTRA-TURRAX®

EUR 1.529,00
Ident. No. 0003737000



T 18 digital ULTRA-TURRAX®

EUR 1.735,00
Ident. No. 0003720000



T 18 digital ULTRA-TURRAX® Package	EUR 2.535,00 0009022800
T 18 digital ULTRA-TURRAX® Disperser	
S 18 N - 19 G Dispersing tool	
H 38 Holding rod	

T 25 digital ULTRA-TURRAX®

EUR 2.535,00
Ident. No. 0003725000



T 50 digital ULTRA-TURRAX®

EUR 4.036,00
Ident. No. 0003787000



TECHNICAL DATA	T 10 BASIC ULTRA-TURRAX®	T 18 DIGITAL ULTRA-TURRAX®	T 25 DIGITAL ULTRA-TURRAX®	T 50 DIGITAL ULTRA-TURRAX®
Process type	Batch	Batch	Batch	Batch
Speed range	8000 – 30 000 rpm	3000 – 25 000 rpm	3000 – 25 000 rpm	600 – 10 000 rpm
Volume range (H ₂ O)	0.0005 – 0.1 l	0.001 – 1.5 l	0.001 – 2.0 l	0.25 – 30 l
Speed control	Stepless	Stepless	Stepless	Stepless
Noise without element	65 dB(A)	75 dB(A)	75 dB(A)	72 dB(A)
Extension arm length	100 mm	160 mm	160 mm	220 mm
Viscosity max.	5000 mPas	5000 mPas	5000 mPas	5000 mPas
Dimensions (W × H × D)	56 × 178 × 66 mm	87 × 271 × 106 mm	87 × 271 × 106 mm	115 × 355 × 139 mm
Protection class according to DIN EN 60529	IP 30	IP 20	IP 20	IP 20



NOMENCLATURE DISPERSING ELEMENTS

Shaft	Outer diameter of stator	Saw-tooth
S 50	45	G - ST
Sealing and bearing	Generator or element	Degree of fineness achieved
KG - HH - G		G = Coarse M = Medium F = Fine
	G = Proved configuration W = Special element	

- N = PTFE bearing
- KV = Ball bearing with vacuum-tight sliding-ring seal with silicon carbide seal rings
- KG - HH = Ball bearing with sliding-ring seals of hard metal allow with FFPM seals rings
- C = Ceramic-coated bearing
- KD = Ball bearing with PTFE seal and FFKM O-ring

All shafts with parts in contact with the product are made of FDA-compliant materials.



S 10 N - 10 G - ST



S 10 D - 7 G - KS - 65



S 18 N - 10 G



S 18 N - 19 G



S 18/25 - ET50

Product	Description	Ident. No.	Price
DISPERSING ELEMENTS FOR T 10 BASIC			
S 10 N - 8 G - ST	Dispersing element, saw-tooth, Ø 8 mm	0004446500	EUR 1.574,00
S 10 N - 10 G - ST	Dispersing element, saw-tooth, Ø 10 mm	0004446700	EUR 1.574,00
S 10 N - 5 G	Dispersing element, Ø 5 mm	0003304000	EUR 1.454,00
S 10 N - 8 G	Dispersing element, Ø 8 mm	0003305500	EUR 1.454,00
S 10 N - 10 G	Dispersing element, Ø 10 mm	0003370100	EUR 1.454,00
S 10 D - 7 G - KS - 65	Plastic dispersing element, Ø 7 mm, 24 pcs.	0020002076	EUR 518,00
S 10 D - 7 G - KS - 110	Plastic dispersing element, Ø 7 mm, 24 pcs.	0020002075	EUR 584,00
DISPERSING ELEMENTS FOR T 18 DIGITAL			
S 18 N - 10 G	Dispersing element, Ø 10 mm	L004639	EUR 1.253,00
S 18 N - 19 G	Dispersing element, Ø 19 mm	L004640	EUR 1.253,00
S 18 D - 10 G - KS	Plastic dispersing element, Ø 10 mm, 12 pcs.	0003452400	EUR 312,00
S 18 D - 14 G - KS	Plastic dispersing element, Ø 14 mm, 12 pcs.	0003452300	EUR 312,00
S 18/25-ET50	Disposable tube	0003452500	EUR 7,70



S 25 N - 18 G



S 25 KV - 2802



S 25 KV - 25 F



S 25 D - 14 G - KS



S 25 KD - 25 G - ST

Product	Description	Ident. No.	Price
DISPERSING ELEMENTS FOR T 25 DIGITAL			
S 25 N - 8 G - ST	Dispersing element, saw-tooth, Ø 8 mm	0004446900	EUR 1.751,00
S 25 N - 10 G - ST	Dispersing element, saw-tooth, Ø 10 mm	0004447100	EUR 1.361,00
S 25 N - 18 G - ST	Dispersing element, saw-tooth, Ø 18 mm	0004447300	EUR 1.369,00
S 25 N - 25 G - ST	Dispersing element, saw-tooth, Ø 25 mm	0004447500	EUR 1.751,00
S 25 N - 8 G	Dispersing element, Ø 8 mm	0001024200	EUR 1.729,00
S 25 N - 10 G	Dispersing element, Ø 10 mm	0000594000	EUR 1.297,00
S 25 N - 18 G	Dispersing element, Ø 18 mm	0000593400	EUR 1.297,00
S 25 KV - 18 G	Dispersing element, Ø 18 mm	0002348000	EUR 2.301,00
S 25 N - 25 G	Dispersing element, Ø 25 mm	0001713300	EUR 1.658,00
S 25 KV - 25 G	Dispersing element, Ø 25 mm	0002466900	EUR 2.423,00
S 25 N - 25 F	Dispersing element, Ø 25 mm	0001713800	EUR 1.751,00
S 25 KV - 25 F	Dispersing element, Ø 25 mm	0002404000	EUR 2.544,00
S 25 KV - 2802	Dissolver stirrer, high speed	0020008825	EUR 2.346,00
S 25 D - 10 G - KS	Plastic dispersing element, Ø 10 mm, 12 pcs.	0003452200	EUR 312,00
S 25 D - 14 G - KS	Plastic dispersing element, Ø 14 mm, 12 pcs.	0003452100	EUR 312,00
S 25 KD - 18 G	Dispersing element, Ø 18 mm	0020002971	EUR 1.685,00
S 25 KD - 25 G	Dispersing element, Ø 25 mm	0020002972	EUR 1.919,00
S 25 KD - 18 G - ST	Dispersing element, saw-tooth, Ø 18 mm	0020002973	EUR 1.751,00
S 25 KD - 25 G - ST	Dispersing element, saw-tooth, Ø 25 mm	0020002974	EUR 2.090,00
S 25 KD - 25 F	Dispersing element, Ø 25 mm	0020002975	EUR 2.139,00
Silentstream	Flow breaker	0003754000	EUR 25,50
S 18/25-ET50	Disposable tube	0003452500	EUR 7,70
TS 25-3	Cleaning tool	0020003013	EUR 117,00
CT.15	Cleaning tube	0020006595	EUR 157,00



Silentstream



TS 25-3

Prevents
vortexing



S 25 EC - T - C - 25 F

Product	Description	Ident. No.	Price
DISPERSING ELEMENTS FOR T 25 EASY CLEAN DIGITAL AND CONTROL			
S 25 EC - C - 18 G	Dispersing element, Ø 18 mm	0020108996	EUR 1.507,00
S 25 EC - C - 25 G	Dispersing element, Ø 25 mm	0020108997	EUR 1.573,00
S 25 EC - C - 25 F	Dispersing element, Ø 25 mm	0025007215	EUR 1.735,00
S 25 EC - C - 18 G - ST	Dispersing element, Ø 18 mm	0025007399	EUR 1.603,00
S 25 EC - C - 25 G - ST	Dispersing element, Ø 25 mm	0025002590	EUR 1.669,00
S 25 EC - T - C - 18 G	Dispersing element, Ø 18 mm, temperature sensor	0020108998	EUR 1.773,00
S 25 EC - T - C - 25 G	Dispersing element, Ø 25 mm, temperature sensor	0020108999	EUR 1.840,00
S 25 EC - T - C - 18 G - ST	Dispersing element, Ø 18 mm, temperature sensor	0025007398	EUR 1.868,00
S 25 EC - T - C - 25 G - ST	Dispersing element, Ø 25 mm, temperature sensor	0025002595	EUR 1.936,00
S 25 EC - T - C - 25 F	Dispersing element, Ø 25 mm, temperature sensor	0025007199	EUR 2.003,00
HS 25 EC - DW	Holder S 25 EC for dish washer	0025007380	EUR 101,00
WiCo T 25 easy clean control	Wireless remote control	0025006310	EUR 976,00

DISPERSING ELEMENTS FOR T 50 DIGITAL

S 50 N - G 45 G	Dispersing element, Ø 45 mm	0008003000	EUR 3.382,00
S 50 N - G 45 G - ST	Dispersing element, saw-tooth, Ø 45 mm	0008039500	EUR 3.382,00
S 50 N - G 45 M	Dispersing element, Ø 45 mm	0008003300	EUR 3.719,00
S 50 N - G 45 F	Dispersing element, Ø 45 mm	0008003900	EUR 3.904,00
S 50 KG - HH - G 45 G	Dispersing element, Ø 45 mm	0008003200	EUR 5.120,00
S 50 KG - HH - G 45 G - ST	Dispersing element, Ø 45 mm	0010000648	EUR 5.120,00
S 50 KG - HH - G 45 M	Dispersing element, Ø 45 mm	0008003500	EUR 5.457,00
S 50 KG - HH - G 45 F	Dispersing element, Ø 45 mm	0008004100	EUR 5.642,00
S 50 KD - G 45 G	Dispersing element, Ø 45 mm	0010000629	EUR 4.542,00
S 50 KD - G 45 G - ST	Dispersing element, saw-tooth, Ø 45 mm	0010000632	EUR 4.542,00
S 50 KD - G 45 M	Dispersing element, Ø 45 mm	0010000630	EUR 4.879,00
S 50 KD - G 45 F	Dispersing element, Ø 45 mm	0010000631	EUR 5.064,00
R 50	Stirring shaft, high speed	0001689300	EUR 2.463,00
R 1405	Propeller, Ø 45 mm	0001289800	EUR 241,00
R 1402	Dissolver, Ø 42 mm	0001243300	EUR 333,00
S 50 N - W 65 SK	Dispersing element with cutting head, Ø 65 mm	0008005100	EUR 3.791,00
S 50 N - W 80 SMK	Jet mixer head, Ø 80 mm	0008006300	EUR 3.549,00

S 50 KG - HH - G 45 G - ST

S 50 N - W 65 SK



S 65 C - G 65 G



S 65 KD - G 65 M



D 80

Product	Description	Ident. No.	Price
DISPERSING ELEMENTS FOR T 65 DIGITAL			
S 65 C - G 65 G	Dispersing element, Ø 65 mm	0010001665	EUR 4.476,00
S 65 C - G 65 M	Dispersing element, Ø 65 mm	0010001666	EUR 4.822,00
S 65 C - G 65 F	Dispersing element, Ø 65 mm	0010001667	EUR 5.034,00
S 65 KG - HH - G 65 G	Dispersing element, Ø 65 mm	0010010765	EUR 5.128,00
S 65 KG - HH - G 65 M	Dispersing element, Ø 65 mm	0010010767	EUR 5.474,00
S 65 KG - HH - G 65 F	Dispersing element, Ø 65 mm	0010010768	EUR 5.686,00
S 65 KD - G 65 G	Dispersing element, Ø 65 mm	0010000641	EUR 4.606,00
S 65 KD - G 65 M	Dispersing element, Ø 65 mm	0010000642	EUR 4.952,00
S 65 KD - G 65 F	Dispersing element, Ø 65 mm	0010000643	EUR 5.164,00
D 60	Dissolver, Ø 60 mm	0020008388	EUR 584,00
D 80	Dissolver, Ø 80 mm	0020008389	EUR 647,00
INLINE DISPERSER SYSTEM - ACCESSORIES			
DK 25.11	Flow chamber	0002518000	EUR 4.379,00
AD 25	Mounting support for DK 25.11	0002562500	EUR 1.057,00
S 25 KV - 25 G-IL	Dispersing element	0002563000	EUR 3.357,00
S 25 KV - 25 F-IL	Dispersing element	0002830200	EUR 3.357,00

IKA laboratory mills are ideal for grinding, pulverizing or chopping samples for routine analyses, either in batch or continuous operation. Grinding results are achieved up to 1 µm particle size or 0.25 mm defined ultimate fineness. Due to a broad spectrum of easily interchangeable beaters and cutters, IKA mills are highly effective for a variety of applications and can also be scaled up for larger volumes.

MULTIDRIVE BASIC AND CONTROL

/// The all-rounder in coarse and fine crushing

Regardless of whether samples are hard, soft, fibrous, wet or dry – the MultiDrive blender can perform a wide range of crushing tasks involving coarse and fine crushing, thanks to the variety of vessels* available. With the MultiDrive basic it is possible to mix or grind; MultiDrive control is also fitted with a dispersion vessel and an autoclavable tube. There is a USB interface available for easy actuation and documentation respectively.

HIGH PERFORMANCE

Excellent crushing performance is guaranteed by a combination of variable rotational speeds, ranging from 3000 rpm to 20 000 rpm, and a 1000 W output.

INTERVAL OPERATION

The option of interval programming is simple to activate at the press of a button. Interval operation is an asset during the coarse crushing of hard samples or for extra thorough blending.

INTEGRATED COOLING

A cooling system is integrated in the milling cup, which allows indirect heat dissipation. Thus, coolant and sample remain separate.

ADDITIONAL CONTROL FEATURES:

TEMPERATURE MEASUREMENT

MultiDrive control offers temperature measurement and vessel recognition using RFID. A temperature limit can be set for temperature-sensitive materials, or for specific planned reactions to protect against overheating.

WEIGHING FUNCTION

The weighing function is also integrated into the user-friendly workflow of the IKA MultiDrive control. Weighing is performed before crushing using the same mixing cup, so that no transfer of contents is required.



MultiDrive control*

EUR 4.254,00

Ident. No. 0025002643

* Vessels don't belong to the scope of delivery.

MultiDrive control MT Package

EUR 4.156,00

Ident. No. 0010007083

MultiDrive control unit
TC 1 protective housing
MT 150.5 Autoclavable
disposable, 150 ml (5 pcs.)



MultiDrive basic*

EUR 3.580,00

Ident. No. 0025002638

* Vessels don't belong to the scope of delivery.



MultiDrive control BT Package

EUR 4.156,00

Ident. No. 0010007086

MultiDrive control unit
TC 1 protective housing
BT 250.5 Autoclavable
disposable, 250 ml (5 pcs.)



MultiDrive basic M 20 Successor Package

EUR 4.500,00

Ident. No. 0010010965

MultiDrive basic unit
MI 250-S
milling chamber, 250 ml



TECHNICAL DATA

	MULTIDRIVE CONTROL	MULTIDRIVE BASIC
Operating principle	Cutting / Impact / Blending / Dispensing	Cutting / Impact / Blending
Speed range	3000 – 20 000 rpm	3000 – 20 000 rpm
Useable volume max.	2000 ml	2000 ml
Feed hardness max.	9 Mohs*	9 Mohs*
Temperature measurement	Yes	–
Weighing function	Yes	–
Milling chamber can be cooled with water / dry ice	Yes / Yes	Yes / Yes
Dimensions (W x H x D)	300 x 350 x 250 mm	300 x 350 x 250 mm
Protection class according to DIN EN 60529	IP 31	IP 31

* with MI 250.3 or MI 400.3 beater, tungsten carbide

A 10 basic

EUR 2.333,00

Ident. No. 0004020700



A 11 basic

EUR 2.802,00

Ident. No. 0002900000



MF 10 basic

EUR 5.339,00

Ident. No. 0002836000



Two different grinding heads can be attached to the drive, see page 87

M 20

EUR 7.550,00

Ident. No. 0001603600



For dry grinding of hard and brittle substances

TECHNICAL DATA	A 10 BASIC	A 11 BASIC	M 20	MF 10 BASIC
Process type	Batch	Batch	Batch	Inline
Operating principle	Cutting / Impact	Cutting / Impact	Cutting / Impact	Cutting / Impact
Speed max.	25 000 rpm	28 000 rpm	20 000 rpm	3000 – 6500 rpm
Useable volume max.	50 ml	80 ml	250 ml	–
Feed hardness	5 Mohs	6 Mohs	5 Mohs	6 Mohs (MF 10.2)
Milling chamber, can be cooled with water / dry ice / liquid nitrogen	Yes / Yes / No	No / Yes / Yes	Yes / Yes / No	No / Yes / No
Dimensions (W x H x D)	130 x 250 x 145 mm	85 x 240 x 85 mm	170 x 350 x 170 mm	320 x 380 x 300 mm
Protection class according to DIN EN 60529	IP 41	IP 43	IP 21	IP 22

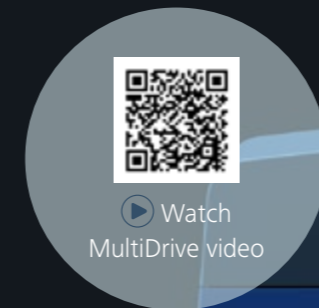

Product	Description	Ident. No.	Price
ACCESSORIES			
BL 2000	Blender vessel, 2000 ml	0025003961	EUR 499,00
BL 2000-T	Blender vessel, 2000 ml, temperature measurement	0025003962	EUR 599,00
MI 250-S	Milling chamber, 250 ml, sealed	0020112097	EUR 920,00
MI 400-S	Milling chamber, 400 ml, sealed	0020112099	EUR 1.048,00
MI 250-T-S	Milling chamber, 250 ml, temperature measurement, sealed	0020112098	EUR 1.049,00
MI 400-T-S	Milling chamber, 400 ml, temperature measurement, sealed	0020112100	EUR 1.192,00
CS 1	Spare filter fume for cover, 5 pcs.	0020113275	EUR 20,00
DI 2000-T	Dispersing vessel, 2000 ml, temperature measurement	0025003960	EUR 1.146,00
BL 2000.1	Standard blend knife, stainless steel	0020023169	EUR 139,00
MI 250.1	Standard beater, stainless steel	0020023166	EUR 82,00
MI 250.2	Star shaped cutter, stainless steel	0020023167	EUR 163,00
MI 250.3	Beater, tungsten carbide	0020023168	EUR 347,00
MI 400.1	Standard beater, stainless steel	0020023170	EUR 104,00
MI 400.2	Star shaped cutter, stainless steel	0020023171	EUR 185,00
MI 400.3	Beater, tungsten carbide	0020023172	EUR 382,00
TC 1	Protective housing for MT 150 and BT 250	0020023489	EUR 157,00
MT 150.5*	Milling tube, autoclavable, 150 ml, 5 pcs. (incl. TS 1)	0020023173	EUR 75,00
BT 250.5*	Blending tube, autoclavable, 250 ml, 5 pcs. (incl. TS 1)	0020023174	EUR 80,00
TS 1	Spare seal with reactivation code, 5 pcs.	0020023490	EUR 17,00

* TC 1 protective housing is mandatory to operate the tube



DI 2000-T

BL 2000-T

MI 250-S

MI 400-TS

TC 1

MT 150.5

BL 2000-T

MI 250.2

MI 400.3

Product	Description	Ident. No.	Price
ACCESSORIES A 10 BASIC			
A 10.1	Stainless steel cutter	0025001680	EUR 61,00
A 10.2	Star-shaped cutter	0025001162	EUR 170,00
A 10.3	Hard metal cutter	0025001161	EUR 324,00
A 10.4	Grinding chamber reduction	0025001664	EUR 131,00
ACCESSORIES A 11 BASIC			
A 11.1	Spare beater, stainless steel	0002904600	EUR 124,00
A 11.2	Cutting blade, stainless steel	0002905200	EUR 208,00
A 11.3	Beater, stainless steel, coated with chromium carbide	0002983000	EUR 260,00
A 11.4	Grinding chamber, polyamide, 250 ml	0002904100	EUR 701,00
A 11.5	Spare grinding chamber, Tefcel, 80 ml	0002983100	EUR 518,00
A 11.6	Double beater, titanium	0003302900	EUR 557,00
A 11.7	Funnel, PTFE	0003048700	EUR 286,00



ACCESSORIES M 20

M 21	Spare cutter, stainless steel	0000328200	EUR 104,00
M 22	Hard metal cutter, tungsten carbide	0000521800	EUR 428,00
M 23	Star-shaped cutter, stainless steel	0001443400	EUR 208,00
M 20.1	Grinding chamber, 250 ml	0008006200	EUR 4.577,00



ACCESSORIES MF 10 BASIC

MF 10.1	Cutting-grinding head	0002870900	EUR 4.209,00
MF 10.2	Impact-grinding head	0002871000	EUR 3.759,00



SIEVES

MF 0.25	Sieve, Ø 0.25 mm	0002938900	EUR 518,00
MF 0.5	Sieve, Ø 0.5 mm	0002939000	EUR 389,00
MF 1.0	Sieve, Ø 1 mm	0002939200	EUR 376,00
MF 2.0	Sieve, Ø 2 mm	0002939400	EUR 365,00
MF 3.0	Sieve, Ø 3 mm	0002939500	EUR 351,00
MF 4.0	Sieve, Ø 4 mm	0002939600	EUR 338,00



MF 10.2

MF 0.25

MF 1.0

MF 2.0

MF 4.0

Discover IKA's new product segment of single-use crushing systems: Innovative solutions for crushing and homogenizing in the laboratory, without the risk of cross-contamination. Our patented Tube Mill control and ULTRA-TURRAX® Tube Drive devices are designed to overcome the challenges of contamination risks and processing small sample volumes.

SINGLE-USE CRUSHING / IVD

/// Maximum efficiency, minimum contamination

TUBE MILL CONTROL

The Tube Mill revolutionizes the field of dry batch milling by introducing the option of using disposable grinding chambers. It has the capability to grind a wide range of soft, fibrous, hard, and brittle samples with exceptional speed and precision, all while eliminating the risk of cross-contamination. IKA's patented universal mill ensures rapid, safe, and consistently reproducible grinding outcomes for your analytical needs.

ULTRA-TURRAX® TUBE DRIVE

The ULTRA-TURRAX® Tube Drive disperser system provides a secure and safeguarded environment for handling infectious sample materials, toxic substances, and high-odor substances. Test procedures can be effortlessly duplicated without any risk of cross-contamination among samples. For the use in human medicine and infection diagnostics, a universally applicable disposable mixing vessel with IVD certification is available.



① **ULTRA-TURRAX® Tube Drive**

EUR 818,00
Ident. No. 0003646000

② **UTTD basic IVD Solution**

EUR 998,00
Ident. No. 0010013007



① **UTTD control Pharma Solution**

EUR 1.611,00
Ident. No. 0010013297

② **UTTD control Life Science Solution**

EUR 1.626,00
Ident. No. 0010013296

③ **UTTD control IVD Solution**

EUR 1.779,00
Ident. No. 0010013008



ULTRA-TURRAX® Tube Drive P control

EUR 1.635,00
Ident. No. 0025005981



ULTRA-TURRAX® Tube Drive P control Workstation

EUR 1.699,00
Ident. No. 0025005836



Further package information on page 164

TECHNICAL DATA	ULTRA-TURRAX® TUBE DRIVE / BASIC	ULTRA-TURRAX® TUBE DRIVE P CONTROL / CONTROL
Process type	Batch	Batch
Speed range	300 – 6000 rpm	400 – 8000 rpm
Timer	–	OLED
Noise without element	50 dB(A)	50 dB(A)
Reversible direction of rotation	–	Yes
Viscosity max.	5000 mPas	5000 mPas
Dimensions (W x H x D)	100 x 40 x 160 mm	122 x 54 x 178 mm
Protection class according to DIN EN 60529	IP 20	IP 20

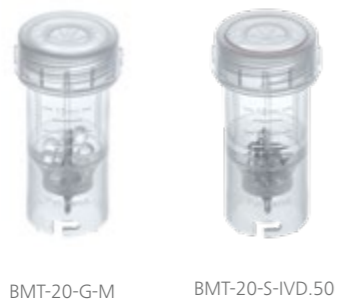

Product	Description	Ident. No.	Price
ST TUBES WITH STIRRING ELEMENT			
ST-20	Tube with stirring element, 20 ml, 25 pcs.	0003703000	EUR 221,00
ST-20-M-gamma	Tube with stirring element, sterile, 20 ml, 20 pcs., membrane lid	0003700500	EUR 247,00
ST-50	Tube with stirring element, 50 ml, 10 pcs.	0003699500	EUR 110,00
ST-50-M-gamma	Tube with stirring element, sterile, 50 ml, 10 pcs., membrane lid	0003701500	EUR 174,00
DT TUBES WITH ROTOR-STATOR ELEMENT			
DT-20	Tube with rotor-stator element, 20 ml, 25 pcs.	0003703100	EUR 230,00
DT-20-M-gamma	Tube with rotor-stator element, sterile, 20 ml, 20 pcs., membrane lid	0003700600	EUR 272,00
DT-20 eco	Tube with rotor-stator element, 20 ml, 25 pcs.	0020003207	EUR 198,00
DT-50	Tube with rotor-stator element, 50 ml, 10 pcs.	0003699600	EUR 124,00
DT-50-M-gamma	Tube with rotor-stator element, sterile, 50 ml, 10 pcs., membrane lid	0003701600	EUR 198,00
DT-50 eco	Tube with rotor-stator element, 50 ml, 10 pcs., membrane lid	0020003213	EUR 111,00
BMT G S TUBES FOR GRINDING WITH GLASS (G) OR STAINLESS STEEL (S) BALLS			
BMT-20-S	Tube with stirring element, stainless steel balls, 20 ml, 25 pcs.	0003703200	EUR 247,00
BMT-20-G	Tube with stirring element, glass balls, 20 ml, 25 pcs.	0003703300	EUR 247,00
BMT-20-S-M-gamma	Tube with stirring element, sterile, stainless steel balls, 20 ml, 20 pcs., membrane lid	0003700701	EUR 284,00
BMT-20-G-M-gamma	Tube with stirring element, sterile, glass balls, 20 ml, 20 pcs., membrane lid	0020017448	EUR 284,00
BMT-20-S-IVD1.50	Tube with stirring element, sterile, IVD label, stainless steel balls, 5 ml NaCl solution, 20 ml, 50 pcs., single sterile packaging	0020103143	EUR 660,00
BMT-20-S-IVD.50	Tube with stirring element, sterile, IVD label, stainless steel balls, 5 ml NaCl solution, 20 ml, 50 pcs., membrane lid, double sterile packaging	0020027186	EUR 835,00
BMT-50-S	Tube with stirring element, stainless steel balls, 50 ml, 10 pcs.	0003699700	EUR 148,00
BMT-50-G	Tube with stirring element, glass balls, 50 ml, 10 pcs.	0003699800	EUR 148,00
BMT-50-S-M-gamma	Tube with stirring element, sterile, stainless steel balls, 50 ml, 10 pcs., membrane lid	0003701700	EUR 211,00



Product	Description	Ident. No.	Price
TUBES WITH DISSOLVER ELEMENT AND MEMBRANE LID			
DIS-50-S-M	Tube with dissolver blade, 50 ml, 10 pcs., stainless steel	0020016316	EUR 113,00
DIS-50-T-M	Tube with dissolver blade, 50 ml, 10 pcs., titanium	0020016317	EUR 137,00
DIS-300-S-M.10	Tube with dissolver blade, 300 ml, 10 pcs., stainless steel	0020016318	EUR 171,00
DIS-300-S-M.50	Tube with dissolver blade, 300 ml, 50 pcs., stainless steel	0020017313	EUR 831,00
TUBES WITH DISSOLVER ELEMENT			
DIS-300-S.10	Tube with dissolver blade, 300 ml, 10 pcs., stainless steel	0020026959	EUR 176,00
DIS-300-S.50	Tube with dissolver blade, 300 ml, 50 pcs., stainless steel	0020026960	EUR 856,00
COVERS			
TC-20-M	Cover, pierceable membrane, 25 pcs.	0003749900	EUR 66,50
TC-50-M	Cover, pierceable membrane, 10 pcs.	0003750000	EUR 43,50
BALLS FOR BMT TUBE			
Glass balls 6	Glass balls, 250 g	0003599200	EUR 65,50
Stainless steel balls 5	Stainless steel balls, 250 g	0003599300	EUR 65,50
FURTHER ACCESSORIES FOR UTTD			
CA.UTTD	Centrifuge adapter for UTTD tubes, 2 pcs.	0020101847	EUR 76,00

IVD



BMT-20-S-IVD

/// For use in human medicine

BMT-20-S-IVD* is a universally applicable disposable mixing vessel for use in human medicine and infection diagnostics. The gamma-sterilized tube contains a stirring unit, 10 stainless steel balls and 5 ml of saline solution and has a screw-on cover with pierceable membrane. BMT-20-S-IVD facilitates and improves micro-biological and molecular-biological analysis of patient samples such as tissue or intraoperative samples.

REDUCED RISK OF CONTAMINATION

No cross-contamination as sample is directly ground inside the vessel, no multiple opening of sample vessel required.

TIME SAVING

Disposable system, shorter sample preparation times, no cleaning of additional vessels.

TRACEABILITY

One single process for transport, grinding / homogenization and storage.

* Released for all EU countries

Tube Mill control

EUR 2.390,00
Ident. No. 0004180000



Tube Mill 100 control

EUR 2.592,00
Ident. No. 0020007144



Designed for grinding chambers with max. 100 ml

Tube Mill control Agriculture Solution

EUR 2.303,00
Ident. No. 0010013298



Tube Mill 100 control Pharma Solution

EUR 2.498,00
Ident. No. 0010013309



Further package information on page 165

TECHNICAL DATA

	TUBE MILL CONTROL	TUBE MILL 100 CONTROL
Process type	Batch	Batch
Operating principle	Cutting / Impact	Cutting / Impact
Speed max.	25 000 rpm	25 000 rpm
Circumferential speed max.	65 m/s	65 m/s
Useable volume max.	40 ml	100 ml
Feed hardness max.	5 Mohs	5 Mohs
Milling chamber, can be cooled with water / dry ice / liquid nitrogen	No / Yes / No	No / Yes / No
Dimensions (W x H x D)	180 x 170 x 300 mm	180 x 212 x 300 mm
Protection class according to DIN EN 60529	IP 30	IP 30



MT 40.10 steril



MT 40 P.10

MT 100

MTT 40

MMT 100

Product	Description	Ident. No.	Price
ACCESSORIES TUBE MILL CONTROL			
MT 40.10	Disposable grinding chamber, 40 ml, 10 pcs.	0004425000	EUR 93,50
MT 40.100	Disposable grinding chamber, 40 ml, 100 pcs.	0020001173	EUR 781,00
MTC 40/100.100	Cover for disposable grinding chamber, 100 pcs.	0020001182	EUR 66,50
MT 40.10 steril	Disposable grinding chamber, sterile, 40 ml, 10 pcs.	0020001984	EUR 159,00
MT 40 P.10	Disposable grinding chamber, bended beater, 40 ml, 10 pcs.	0020017838	EUR 105,00
MT 40 P.100	Disposable grinding chamber, bended beater, 40 ml, 100 pcs.	0020011531	EUR 912,00
MT 100.10	Disposable grinding chamber, 100 ml, 10 pcs.	0020008386	EUR 105,00
MT 100.10 steril	Disposable grinding chamber, sterile, 100 ml, 10 pcs.	0020012571	EUR 185,00
MT 100.50	Disposable grinding chamber, 100 ml, 50 pcs.	0020006984	EUR 464,00
MMT 40.1	Multi-use milling tube, 40 ml	0020003165	EUR 273,00
MMT 100.1	Multi-use milling tube, 100 ml	0020016315	EUR 299,00
MTT 40.10	Disposable grinding chamber, titanium beater, 40 ml, 10 pcs.	0020015380	EUR 159,00
MTT 100.10	Disposable grinding chamber, titanium beater, 100 ml, 10 pcs.	0020019576	EUR 185,00
A-MMT.100	Abrasion set for MMT 40.1 MMT 100.1, 100 sealing, 5 beaters, 5 couplings	0020003378	EUR 185,00

Display viscosity changes through sensitive torque measuring sensor: the STARVISC measuring stirrers makes it possible. The device covers a broad range of applications and is particularly helpful during product development: STARVISC already clearly indicates while running research programmes as to whether the stirred substance can be used as desired.

STARVISC 200-2.5 CONTROL

/// The only device that can do everything at the same time



HIGH-PRECISION MEASUREMENT

During the mixing process a highly sensitive torque measuring sensor allows further conclusions on viscosity changes, directly in the product. This eliminates the regular sampling, rather time consuming offline measurement process.

VISCOSITY CALCULATION

The viscosity can be correlated from the torque readings based on a well defined set-up under reproducible conditions.

REMOVABLE CONTROL UNIT

The modern TFT display is removable. This means that STARVISC can also be controlled from a safe distance.

POWERFUL STIRRER

Even highly viscous substances can be intensively stirred using the powerful STARVISC stirrer. Quantities of up to 100 liters can be processed.

STARVISC 200-2.5 control

EUR 7.112,00

Ident. No. 0025003604

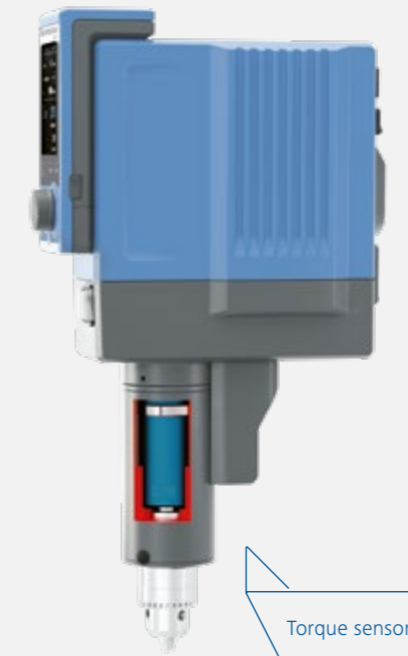

Torque sensor

TECHNICAL DATA	STARVISC 200-2.5 CONTROL
Stirring quantity max. (H ₂ O)	100 l
Torque max. at stirring shaft	200 Ncm
Torque I max.	200 Ncm
Torque II max.	40 Ncm
Speed range I (high torque)	0 6 – 400 rpm
Speed range II (high speed)	0 30 – 2000 rpm
Display	TFT
Viscosity max.	100 000 mPas
Dimensions (W × H × D)	91 × 395 × 231 mm
Protection class according to DIN EN 60529	IP 40

Name	Description	Ident. No.	Price
------	-------------	------------	-------

ACCESSORIES STARVISC 200-2.5 CONTROL

STIRRING ELEMENTS

R 1302	Dissolver stirrer, Ø 100 mm	0002387900	EUR 647,00
R 1330	Anchor stirrer, Ø 45 mm	0002022300	EUR 441,00
R 1331	Anchor stirrer, Ø 90 mm	0002022400	EUR 534,00
R 1345	Propeller stirrer, 4-bladed, Ø 100 mm	0000741300	EUR 213,00
R 1375	Paddle stirrer, Ø 70 mm	0000757700	EUR 208,00

BOSS HEAD CLAMPS

R 270	Boss head clamp, clamping range Ø 25 – 36 mm	0002657800	EUR 137,00
R 271	Boss head clamp, clamping range Ø 34 mm	0002664000	EUR 221,00

STANDS

R 2722	H-stand, 1010 mm	0001412000	EUR 794,00
R 2723	Telescopic stand, H 620 – 1010 mm	0001412100	EUR 1.473,00

SOFTWARE

labworldsoft® 6 Visc	Laboratory software for ROTAVISC - download	0020101872	EUR 1.124,00
labworldsoft® 6 Starter	For configurations up to 3 devices	0020019397	EUR 5.065,00
labworldsoft® 6 Pro	For all configurations – any number of devices can be controlled at the same time	0020017366	EUR 11.537,00

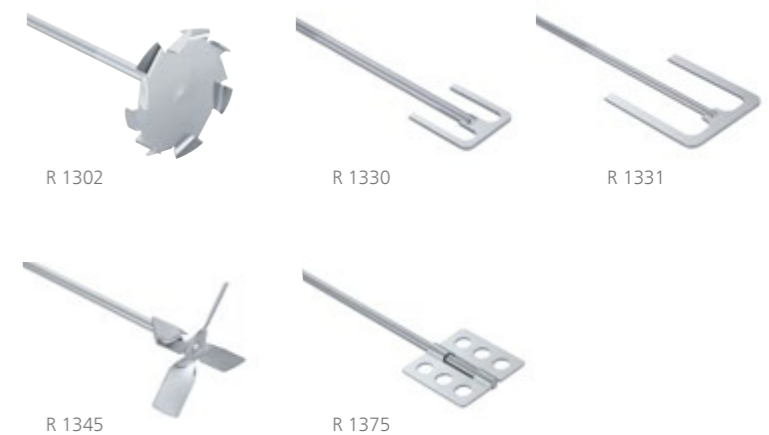

"Flow" is the term used to describe the wonderful mental state in which everything moves along by itself. And with the IKA viscometers, the perfect flow also comes to your laboratory. The IKA ROTAVISC range determines the viscosity of liquids in all applications, from the laboratory to quality control. Stepless, fast and accurate. The measuring process is intuitive and standardized, as well as working with the well-known IKA menu structure for laboratory devices. There are four instruments for different viscosity ranges, the attractive Complete and HELI packages, and an instrument variant with ball bearing technology.

ROTAVISC SBS

/// The viscometer with ball bearing

The ROTAVISC SBS viscometer complements our ROTAVISC series: In these instruments, a robust ball bearing (Steel Ball Bearing Suspending) replaces the classic jewel bearing. The operation corresponds to the well-known user-friendly principle of the entire ROTAVISC series.

Printing function via RS 232 interface



FOR HEAVY USE

This ball bearing cannot be overused at all. When changing the spindle, you also no longer have to lift the coupling shaft. We recommend a viscometer in the SBS variant especially for:

- › very high sample throughput
- › rather rough environment / handling
- › frequent spindle change
- › frequent change of location of the device

COMBINE AND UPGRADE

In the SBS variant, the ROTAVISC me-vi, hi-vi I and hi-vi II viscometer models are now available as Complete and HELI Packages. Do you have a viscometer with jewel bearings? Then we can upgrade it to a ball bearing model if requested. Only ROTAVISC lo-vi for the low viscosity range will continue to be manufactured only with jewel bearings.

SPINDLE HOLDER

The SP-RACK spindle holder for ROTAVISC spindles is made of stainless steel (AISI 304 / 1.4301) and offers space for up to twelve different spindles, depending on the spindle size. Here they can be stored near the viscometers or hung up for drying.

① ROTAVISC lo-vi HELI Complete

EUR 3.899,00
Ident. No. 0025008225

② ROTAVISC me-vi HELI Complete

EUR 3.899,00
Ident. No. 0025008226

③ ROTAVISC hi-vi I HELI Complete

EUR 3.899,00
Ident. No. 0025008227

④ ROTAVISC hi-vi II HELI Complete

EUR 3.899,00
Ident. No. 0025008228

OUR PACKAGES

HELI Complete:
including motorized HELISTAND



With Ball Bearing Technology

① ROTAVISC SBS me-vi HELI Complete

EUR 4.326,00
Ident. No. 0010007716

② ROTAVISC SBS hi-vi I HELI Complete

EUR 4.326,00
Ident. No. 0010007688

③ ROTAVISC SBS hi-vi II HELI Complete

EUR 4.326,00
Ident. No. 0010007703



TECHNICAL DATA	ROTAVISC HELI COMPLETE
Viscosity accuracy	± 1 % FSR
Viscosity repeatability	0.2 % FSR
Display	TFT
Working temperature	Min.: -100 °C Max.: +300 °C
Speed	0.01 – 200 rpm
Speed setting accuracy	in range 0.01 – 1: 0.01 rpm in range 1 – 200: 0.1 rpm
Temperature measurement resolution	0.1 K
Connection for ext. temperature sensor	PT 100
Interfaces	USB, RS 232
Dimensions (W x H x D)	351 x 629 x 372 mm
Weight	7.1 kg
Protection class according to DIN EN 60529	IP 40

TECHNICAL DATA	HELISTAND
Stroke max.	142 mm
Diameter	16 mm
Dynamic load	3.2 kg
Overload protection	Yes
Height adjustable safety switch	Yes
Dimensions (W x H x D)	351 x 343 x 252 mm
Weight	5.5 kg
Protection class according to DIN EN 60529	IP 40

- ① **ROTAVISC lo-vi Complete**
EUR 3.398,00
Ident. No. 0025000310
- ② **ROTAVISC me-vi Complete**
EUR 3.398,00
Ident. No. 0025000311
- ③ **ROTAVISC hi-vi I Complete**
EUR 3.398,00
Ident. No. 0025000312
- ④ **ROTAVISC hi-vi II Complete**
EUR 3.398,00
Ident. No. 0025000313



- ① **ROTAVISC SBS me-vi Complete**
EUR 3.848,00
Ident. No. 0010007714
- ② **ROTAVISC SBS hi-vi I Complete**
EUR 3.848,00
Ident. No. 0010007686
- ③ **ROTAVISC SBS hi-vi II Complete**
EUR 3.848,00
Ident. No. 0010007701

With Ball Bearing Technology



OUR PACKAGES

Complete:
including ROTASTAND

TECHNICAL DATA	ROTAVISC
Viscosity accuracy	± 1 % FSR
Viscosity repeatability	0.2 % FSR
Display	TFT
Working temperature	Min.: -100 °C Max.: +300 °C
Speed	0.01 – 200 rpm
Speed setting accuracy	in range 0.01 – 1: 0.01 rpm in range 1 – 200: 0.1 rpm
Temperature measurement resolution	0.1 K
Connection for ext. temperature sensor	PT 100
Interfaces	USB, RS 232
Dimensions (W x H x D)	351 x 629 x 372 mm
Weight	7.1 kg
Protection class according to DIN EN 60529	IP 40

MEASURING RANGES	
ROTAVISC lo-vi	
Viscosity measuring range*	1 – 6 000 000 mPas
ROTAVISC me-vi	
Viscosity measuring range	100 – 40 000 000 mPas
ROTAVISC hi-vi I	
Viscosity measuring range	200 – 80 000 000 mPas
ROTAVISC hi-vi II	
Viscosity measuring range	800 – 320 000 000 mPas

* 1 mPas with ELVAS-1



Our product portfolio is ideally oriented towards viscosity measurement in the following fields of application:

- lo-vi** // for juices, solvents, edible oils, inks, liquid soaps
- me-vi** // for paints / varnishes, mayonnaise, dairy products, ketchup
- hi-vi I & hi-vi II** // for pastes, ointments, molasses, gels

CBC VISC LITE
Ident. No. 0020102007

Available Q2/2024

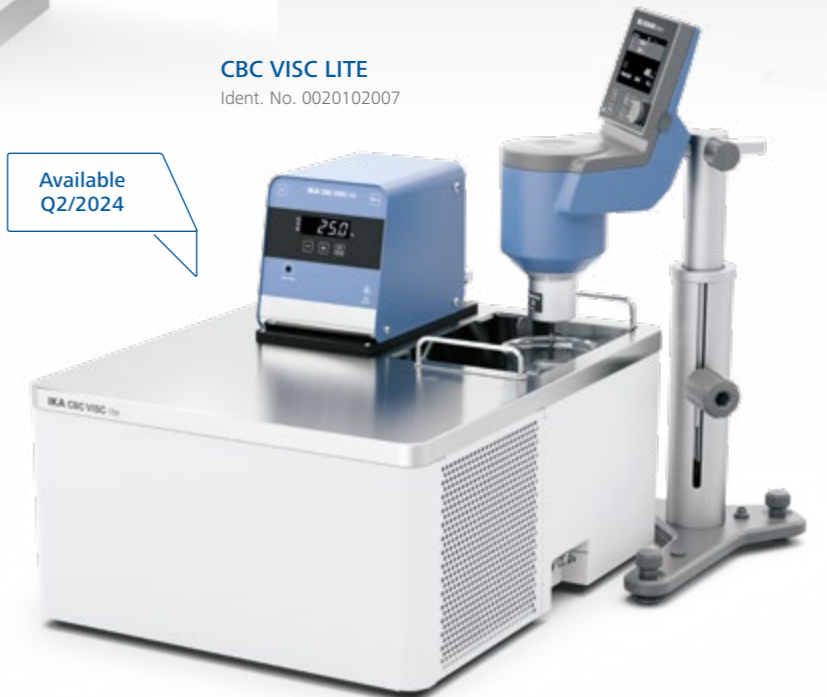

CBC VISC LITE
Precise and fast temperature control is crucial for analyzing the viscosity-temperature dependency or measuring viscosity at a precisely defined temperature. The new CBC VISC lite covers a wide temperature range from -25 °C to 125 °C and is designed to be combined with the IKA ROTAVISC viscometers.

- › Two 600 ml standard beakers can be controlled inside the bath at once
- › Optimized water flow management in the insulated bath for fast and precise temperature control
- › Compatible with labworldsoft® to realize more advanced automated measurement processes

ROTAVISC is not included in scope of delivery.



ROTASTAND



SP RACK



HELISTAND

Product	Description	Ident. No.	Price
STANDS			
ROTASTAND	Stand for ROTAVISC	0020006787	EUR 923,00
HELISTAND	Electrical stand for ROTAVISC	0025007567	EUR 1.209,00
HELISTAND Set	Electrical stand incl. T-spindle set	0025008233	EUR 1.629,00
SP RACK	Spindle rack	0020104809	EUR 68,50
SOFTWARE			
labworldsoft® 6 Visc	Laboratory software for ROTAVISC - download	0020101872	EUR 1.124,00



HELISTAND Set
(HELISTAND + T-SP-Set)



Adapter: DIN S-1



Adapter: O DIN S-1



Adapter: VOLS-1



Hook Connector

Quick Connector



Spindle set: VAN-1

Product	Description	Ident. No.	Price
ADAPTERS			
DINS-1	DIN adapter set	0025000387	EUR 2.283,00
O DIN S-1	Open DIN adapter set	0025000326	EUR 2.283,00
SAS-1	Spiral adapter set	0025000377	EUR 1.204,00
ELVAS-1	Extremely low viscosity adapter set	0025000390	EUR 1.511,00
VOLS-1	Low volume adapter set	0025000352	EUR 1.297,00
VOLS-1 flex	Adapter set for small volumes, without spindle and chamber	0020114188	EUR 660,00
ACCESSORIES VISCOMETERS			
DWB 600	Double-walled beaker 600 ml	0020024575	EUR 807,00
BH 600	Clamp for 600 ml beaker	0025000400	EUR 155,00
Hook Connector	Hook connector for spindles	0025000338	EUR 161,00
Quick Connector	Quick connector for spindles	0025000339	EUR 161,00
PT 100.8	Temperature sensor, stainless steel, Ø 3 mm, 75 mm	0025000413	EUR 65,50
SPINDLE SET			
SP set-1	Standard spindle set (SP1 - SP4)	0025000319	EUR 228,00
SP set-2	Standard spindle set (SP7 - SP12)	0025000329	EUR 193,00
T-SP-Set	T-spindle set	0025007765	EUR 420,00
VAN-1	Vane spindle set	0025000407	EUR 1.116,00



SP-5

SP-6



T-SP-6 – T-SP-1



VOL-SP-7.1



VOL-SP-2.1



VOL-SP-9



VOL-SP-11

Product	Description	Ident. No.	Price
SPINDLES SINGLE			
SP-1	Standard spindle	0025006828	EUR 91,50
SP-2	Standard spindle	0025006829	EUR 86,50
SP-3	Standard spindle	0025006830	EUR 84,00
SP-4	Standard spindle	0025006831	EUR 79,00
SP-5	Standard spindle	0025006832	EUR 155,00
SP-6	Standard spindle	0025006833	EUR 155,00
SP-7	Standard spindle	0025006834	EUR 66,50
SP-8	Standard spindle	0025006835	EUR 64,50
SP-9	Standard spindle	0025006836	EUR 64,50
SP-10	Standard spindle	0025006837	EUR 61,00
SP-11	Standard spindle	0025006838	EUR 58,00
SP-12	Standard spindle	0025006839	EUR 46,50
T-SP-1	T-spindle	0025008238	EUR 68,50
T-SP-2	T-spindle	0025008239	EUR 68,50
T-SP-3	T-spindle	0025008240	EUR 68,50
T-SP-4	T-spindle	0025008241	EUR 68,50
T-SP-5	T-spindle	0025008242	EUR 68,50
T-SP-6	T-spindle	0025008243	EUR 68,50
T-SP-nut	T-spindle nut	0020108874	EUR 61,00
T-SP-coupling	T-spindle coupling	0020108842	EUR 100,00
VAN-SP-1	Vane spindle	0025006853	EUR 381,00
VAN-SP-2	Vane spindle	0025006854	EUR 308,00
VAN-SP-3	Vane spindle	0025006855	EUR 281,00
VAN-SP-4	Vane spindle	0025006856	EUR 264,00
VAN-SP-5	Vane spindle	0025008376	EUR 249,00
S-SP	Spiral spindle	0025006843	EUR 173,00
S-C-1	Chamber for S-SP spiral spindle	0020108896	EUR 607,00
SCB	Spindle brush for S-SP	0020108882	EUR 46,50
VOL-SP-6.7	Spindle for VOLS-1, 6.7 ml	0025006845	EUR 351,00
VOL-SP-7.1	Spindle for VOLS-1, 7.1 ml	0025006849	EUR 351,00
VOL-SP-16.1	Spindle for VOLS-1, 16.1 ml	0025006848	EUR 362,00
VOL-SP-10.4	Spindle for VOLS-1, 10.4 ml	0025006850	EUR 362,00
VOL-SP-11	Spindle for VOLS-1, 11 ml	0025006851	EUR 362,00
VOL-SP-13.5	Spindle for VOLS-1, 13.5 ml	0025006852	EUR 362,00
VOL-SP-9	Spindle for VOLS-1, 9 ml	0025006846	EUR 362,00
VOL-SP-9.4	Spindle for VOLS-1, 9.4 ml	0025006847	EUR 362,00
VOL-SP-2.1	Spindle for 2.1 ml chamber	0025007061	EUR 362,00



VOL-C-RTD-3.8



VOL-C-RTD-4.2



CAL-O-5



CAL-O-100000

Product	Description	Ident. No.	Price
VOL-SP-2.1-S	Solid shaft spindle	0020118239	EUR 362,00
VOL-C-RTD-1	VOL-C-RTD-1 chamber	0025007603	EUR 438,00
VOL-C-RTD-2.1	2.1 ml chamber for VOLS-1	0025007064	EUR 438,00
VOL-SP-3.8	Spindle for 3.8 ml chamber	0025007062	EUR 362,00
VOL-C-RTD-3.8	3.8 ml chamber for VOLS-1	0025007065	EUR 438,00
VOL-SP-4.2	Spindle for 4.2 ml chamber	0025007063	EUR 362,00
VOL-C-RTD-4.2	4.2 ml chamber for VOLS-1	0025007066	EUR 438,00
VOLS 1.11	Extension connector	0020107301	EUR 104,00
VOLS 1.21	Cover for VOLS chamber	0020108881	EUR 29,50
ELVAS-SP	ELVAS Spindle	0025006844	EUR 362,00
ELVAS-C	ELVAS sample chamber (open)	0020107138	EUR 324,00
ELVAS-C-C	Closed chamber for ELVAS-1	0025008373	EUR 214,00
DIN-SP-5	DIN spindle 5	0025006840	EUR 362,00
DIN-SP-6	DIN spindle 6	0025006841	EUR 362,00
DIN-SP-7	DIN spindle 7	0025006842	EUR 362,00
DIN-C-1	Chamber for DIN-SP-5	0020108883	EUR 370,00
DIN-C-2	Chamber for DIN-SP-6, DIN-SP-7	0020108885	EUR 370,00
O-DIN-C-1	Open chamber for DIN-SP-5	0020108887	EUR 324,00
O-DIN-C-2	Open chamber for DIN-SP-6	0020108888	EUR 324,00
O-DIN-C-3	Open chamber for DIN-SP-7	0020108889	EUR 324,00
CC-1	Chamber cap (6 pcs.) for ELVAS / DINS	0020107043	EUR 33,00

STANDARD SILICONE OILS

CAL-O-5	Standard silicone oil, 5 mPas, 25 °C, 500 ml	0025000397	EUR 149,00
CAL-O-10	Standard silicone oil, 10 mPas, 25 °C, 500 ml	0025000398	EUR 149,00
CAL-O-50	Standard silicone oil, 50 mPas, 25 °C, 500 ml	0025000399	EUR 149,00
CAL-O-100	Standard silicone oil, 100 mPas, 25 °C, 500 ml	0025000434	EUR 149,00
CAL-O-500	Standard silicone oil, 500 mPas, 25 °C, 500 ml	0025000435	EUR 149,00
CAL-O-1000	Standard silicone oil, 1000 mPas, 25 °C, 500 ml	0025000436	EUR 149,00
CAL-O-5000	Standard silicone oil, 5000 mPas, 25 °C, 500 ml	0025000437	EUR 149,00
CAL-O-12500	Standard silicone oil, 12 500 mPas, 25 °C, 500 ml	0025000466	EUR 149,00
CAL-O-30000	Standard silicone oil, 30 000 mPas, 25 °C, 500 ml	0025000467	EUR 149,00
CAL-O-60000	Standard silicone oil, 60 000 mPas, 25 °C, 500 ml	0025000468	EUR 149,00
CAL-O-100000	Standard silicone oil, 100 000 mPas, 25 °C, 500 ml	0025000469	EUR 149,00

IKA's small but excellent product group of vacuum pumps is perfectly suitable for many dry and oil-free applications in the laboratory. The devices stand out due to their high suction capacity and ease of service. Their membranes are particularly chemical resistant as well. The diaphragm vacuum pumps are suitable for many vacuum tasks in the lab such as separation, filtration or degassing. They are even suitable to construct a laboratory vacuum system in which you can switch any number of vacuum controllers in series according to the application. In addition, they perfectly complement IKA's rotary evaporators or laboratory reactors.

VC 10 LITE AND PRO

/// Vacuum controllers for all applications

Universal vacuum controller VC 10 lite and pro for controlled evacuation of air (gas) from laboratory equipment as well as for classical separation, filtration or drying tasks in the laboratory.

For additional safety for the user and the environment, it is recommended to use the vacuum safety emission condenser VSE 1, which prevents solvents from entering the ambient air.

The controllers are ready for use in numerous applications and are easy to install. The integrated valve cleaning function guarantees a particularly long service life of the vacuum system. By venting the system, solvent pressure levels in the pump can be completely removed.

Everything from one source



VACSTAR digital

EUR 2.834,00

Ident. No. 0020016236

VACSTAR control

EUR 4.540,00

Ident. No. 0020109375



TECHNICAL DATA

	VACSTAR DIGITAL VACSTAR CONTROL
Pump rate max.	1.32 m ³ / h
Max. pumping capacity	22 l / min
Boiling point detection	No Yes
Solvent library	No Yes
Speed range	285 – 1200 rpm
Vacuum sensor	No Yes
Two-point control	Yes No
Min. input pressure	2 mbar
Max. input pressure	1030 mbar
Dimensions (W x H x D)	150 x 375 x 370 mm 270 x 435 x 500 mm
Protection class acc. to DIN EN 60529	IP 20
RS 232 / USB interface	Yes

Product	Ident. No.	Price
---------	------------	-------

ACCESSORIES VACUUM PUMPS

VSE 1 vacuum safety emission	0035001873	EUR 574,00
VH.SI.8 vacuum hose, silicone, Ø 8 mm, 1 m	0020013886	EUR 45,50



VSE 1



VH.SI.8

MVP 10 basic

EUR 1.968,00
Ident. No. 0003980000



Product	Ident. No.	Price
ACCESSORIES MVP 10 BASIC		
VCV 1 vacuum control valve manual	0020004850	EUR 716,00
VCV 2 vacuum control valve digital	0020004893	EUR 1.185,00
VSS 1 vacuum safety set	0020005194	EUR 1.002,00
VH.SI.8 vacuum hose, silicone, Ø 8 mm, 1 m	0020013886	EUR 45,50
Y hose connector 8 mm	0020010963	EUR 6,10



VSS 1



VCV 1



VC 10.300



VC 10.400

TECHNICAL DATA	MVP 10 BASIC
Max. pumping capacity	28.3 l / min
Max. pump rate	1.7 m³/ h
Speed range	1380 – 1680 rpm
Vacuum sensor	No
Min. input pressure	7 mbar
Max. input pressure	1050 mbar
Dimensions (W x H x D)	245 x 155 x 320 mm
Protection class acc. to DIN EN 60529	IP 54
Voltage	230 / 115 / 100 V

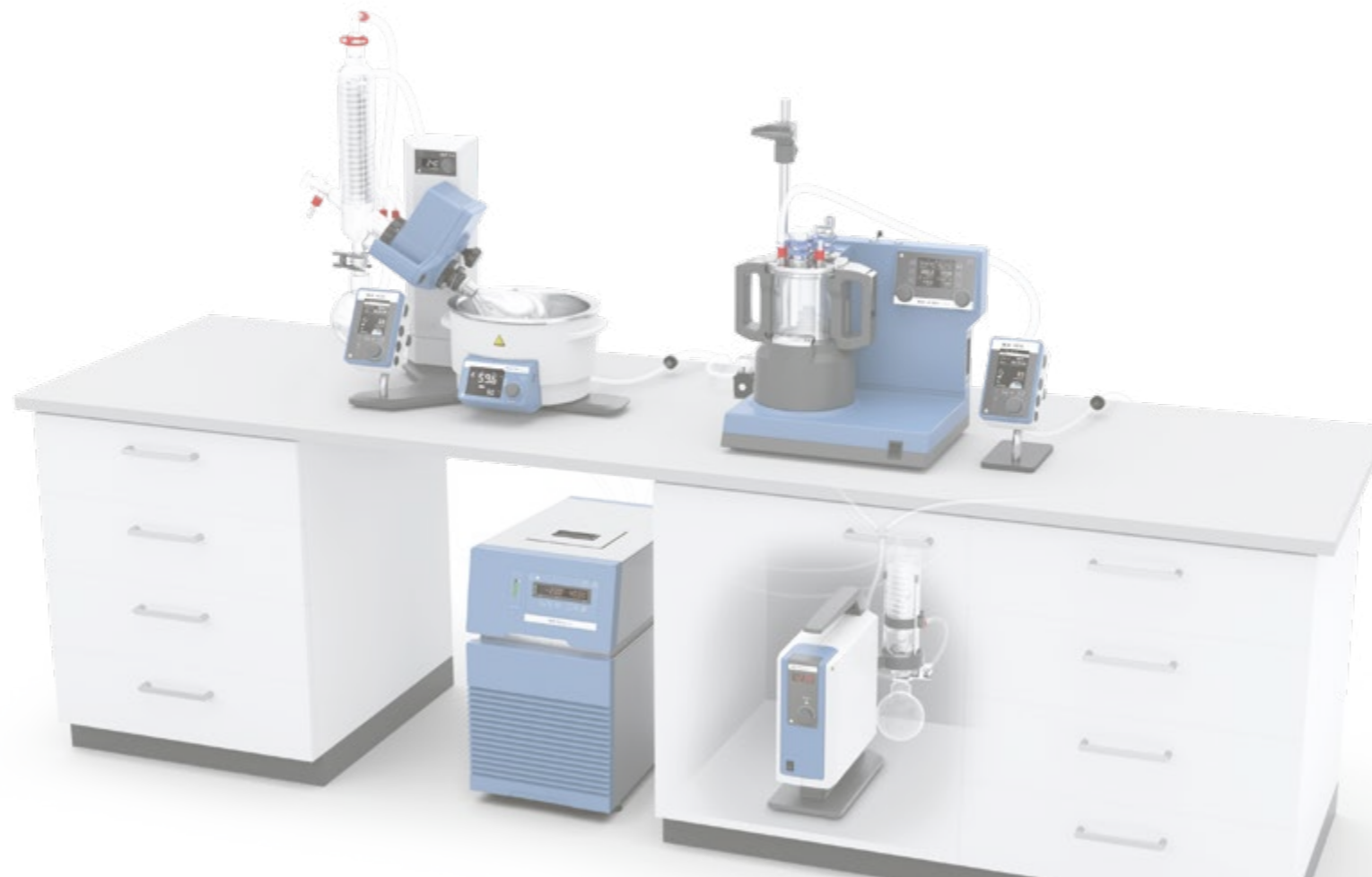

Product	Ident. No.	Price
ACCESSORIES VACUUM CONTROLLER		
VC 10.300 check valve	0020011105	EUR 210,00
VC 10.400 table holder	0035001735	EUR 259,00
VC 10.500 Stand pole	0035002702	EUR 95,00

- ① **VC 10 lite**
EUR 988,00
Ident. No. 0020111998
- ② **VC 10 pro**
EUR 1.488,00
Ident. No. 0020112031



TECHNICAL DATA	VC 10 LITE	VC 10 PRO
Vacuum sensor		Yes
Min. input pressure		1 mbar
Max. input pressure		1050 mbar
Boiling point detection	–	Yes
Vacuum valve	–	Yes
Two-point regulation	–	Yes
Analog speed vacuum control		Yes
Ventilation valve		Yes
Automatic mode	No	Yes
Manual mode	Yes	Yes
Programmable		Yes
Dimensions (W x H x D)		95 x 150 x 110 mm
Protection class acc. to DIN EN 60529		IP 20
RS 232 / USB interface		Yes

According to DIN 12876, our wide range of chillers, heating bath circulators and immersion circulators are suitable for a temperature range from -30 to 250 °C. All temperature control devices meet the highest requirements for precision, safety, performance and intelligence. With the new circulators in the "lite" series, we are even better able to meet our customers' requirements.

STRAIGHT TO THE POINT

/// Temperature control series "lite"

FOCUS ON THE ESSENTIAL

Sometimes you need a laboratory device only for a very specific application. For example, as a peripheral device or an entry-level device. Laboratory devices within the lite series are exactly that: devices that offer you the essential basic functions. They have everything you need. And deliberately nothing more.

POWERFUL AND HIGH-QUALITY

Lite devices are powerful and of high quality, with a focus on essential basic functions, excellent performance and efficient operation. They are also made for the future in the laboratory: RC 2 lite, HRC 2 lite and CBC VISC lite work with the natural refrigerant R 290.

Available Q2/2024



ICC 100 lite

EUR 800,00
Ident. No. 0020105647

ICC 150 lite

EUR 950,00
Ident. No. 0020105581

Available Q2/2024



① ICC basic

EUR 1.360,00
Ident. No. 0004134400

② ICC control

EUR 2.076,00
Ident. No. 0004136600



IC basic

EUR 2.981,00
Ident. No. 0003861000

IC control

EUR 3.866,00
Ident. No. 0003863000

CC 1 cooling coil included in delivery



TECHNICAL DATA	ICC 100 lite	ICC 150 lite	ICC BASIC / CONTROL	IC BASIC / CONTROL
Appliance type	Compact immersion circulator	Compact immersion circulator	Compact immersion circulator	Immersion circulator
Heat output (230 / 115 V)	2000 / –	2000 / –	2000 / 1000 W	2500 / 1250 W
Temperature range	RT +10 °C* – 100 °C	RT +10 °C* – 150 °C	RT +10 °C** – 150 °C	RT +10 °C – 250 °C***
Display	LED	LED	LED / TFT	LED / TFT (wireless)
Temperature stability DIN 12876	± 0.05 K	± 0.05 K	± 0.02 K / ± 0.01 K	± 0.02 K / ± 0.01 K
Max. flow rate	–	18 l/min	18 l/min	31 l/min
Max. pump pressure	–	0.3 bar	0.3 bar	0.61 bar
Min. suction pressure	–	0.1 bar	0.2 bar	0.45 bar
Dimensions (W × H × D)	135 × 180 × 303 mm	135 × 180 × 303 mm	145 × 340 × 200 mm	285 × 313 × 291 mm

* Possible operating temperatures with cooling coil: -25 °C to 100/150 °C

** Possible operating temperatures with cooling coil: -20 °C to 150 °C

*** Possible operating temperatures with cooling coil: -20 °C to 250 °C

Product	Description	Bath size	Bath opening (W x D)*	Ident. No.	Price
HEATING BATH CIRCULATORS					
ICC 100 lite eco 8	Package with 8 l eco bath	S	188 x 105 mm	0010013176	EUR 1.323,00
ICC 100 lite eco 18	Package with 18 l eco bath	L	245 x 305 mm	0010013187	EUR 1.477,00
ICC 150 lite pro 9	Package with 9 l pro bath	S	195 x 100 mm	0010013199	EUR 1.640,00
ICC 150 lite pro 12	Package with 12 l pro bath	M	255 x 127 mm	0010013210	EUR 1.706,00
ICC 150 lite pro 20	Package with 20 l pro bath	L	255 x 309 mm	0010013221	EUR 1.829,00
ICC basic eco 8	Package ICC basic, 8 l eco bath	S	188 x 105 mm	0008034900	EUR 1.849,00
ICC basic pro 9	Package ICC basic, 9 l pro bath	S	195 x 100 mm	0008035100	EUR 2.023,00
ICC basic pro 12	Package ICC basic, 12 l pro bath	M	255 x 127 mm	0010000414	EUR 2.102,00
ICC basic eco 18	Package ICC basic, 18 l eco bath	L	245 x 305 mm	0008035000	EUR 2.016,00
ICC basic pro 20	Package ICC basic, 20 l pro bath	L	255 x 309 mm	0008035200	EUR 2.225,00
ICC control eco 8	Package ICC control, 8 l eco bath	S	188 x 105 mm	0008035300	EUR 2.529,00
ICC control pro 9	Package ICC control, 9 l pro bath	S	195 x 100 mm	0008035500	EUR 2.703,00
ICC control pro 12	Package ICC control, 12 l pro bath	M	255 x 127 mm	0010000415	EUR 2.783,00
ICC control eco 18	Package ICC control, 18 l eco bath	L	245 x 305 mm	0008035400	EUR 2.696,00
ICC control pro 20	Package ICC control, 20 l pro bath	L	255 x 309 mm	0008035600	EUR 2.905,00
COMBINED HEATING BATH CIRCULATORS					
ICC 150 lite pro 9 c	Package with 9 l pro bath, cover	S	195 x 100 mm	0010013233	EUR 1.964,00
ICC 150 lite pro 12 c	Package with 12 l pro bath, cover	M	255 x 127 mm	0010013244	EUR 2.067,00
ICC basic eco 8 c	Package ICC basic, 8 l eco bath, cover	S	188 x 105 mm	0008035700	EUR 2.322,00
ICC basic pro 9 c	Package ICC basic, 9 l pro bath, cover	S	195 x 100 mm	0008035900	EUR 2.496,00
ICC basic pro 12 c	Package ICC basic, 12 l pro bath, cover	M	255 x 127 mm	0010000416	EUR 2.613,00
ICC basic eco 18 c	Package ICC basic, 18 l eco bath, cover	L	245 x 305 mm	0008035800	EUR 2.552,00
ICC basic pro 20 c	Package ICC basic, 20 l pro bath, cover	L	255 x 309 mm	0008036000	EUR 2.761,00
ICC control eco 8 c	Package ICC control, 8 l eco bath, cover	S	188 x 105 mm	0008036100	EUR 3.354,00
ICC control pro 9 c	Package ICC control, 9 l pro bath, cover	S	195 x 100 mm	0008036300	EUR 3.528,00
ICC control eco 18 c	Package ICC control, 18 l eco bath, cover	L	245 x 305 mm	0008036200	EUR 3.584,00
ICC control pro 12 c	Package ICC control, 12 l pro bath, cover	M	255 x 127 mm	0010000417	EUR 3.645,00
ICC control pro 20 c	Package ICC control, 20 l pro bath, cover	L	255 x 309 mm	0008036400	EUR 3.793,00
PACKAGES WITH MAGNETIC STIRRER					
ICC basic IB R RO 15 eco	Package ICC basic with magnetic stirrer RO 15 and bath	L	317 x 492 mm	0010002471	EUR 4.742,00
ICC control IB R RO 15 eco	Package ICC control with magnetic stirrer RO 15 and bath	L	317 x 492 mm	0010002474	EUR 5.387,00
ICC basic IB R RO 15 pro	Package ICC basic with magnetic stirrer RO 15 and bath	L	317 x 492 mm	0010006740	EUR 5.631,00
ICC control IB R RO 15 pro	Package ICC control with magnetic stirrer RO 15 and bath	L	317 x 492 mm	0010006736	EUR 6.276,00

eco: plastic bath | pro: stainless steel bath

* Size of plate that can be placed at the bottom of the bath

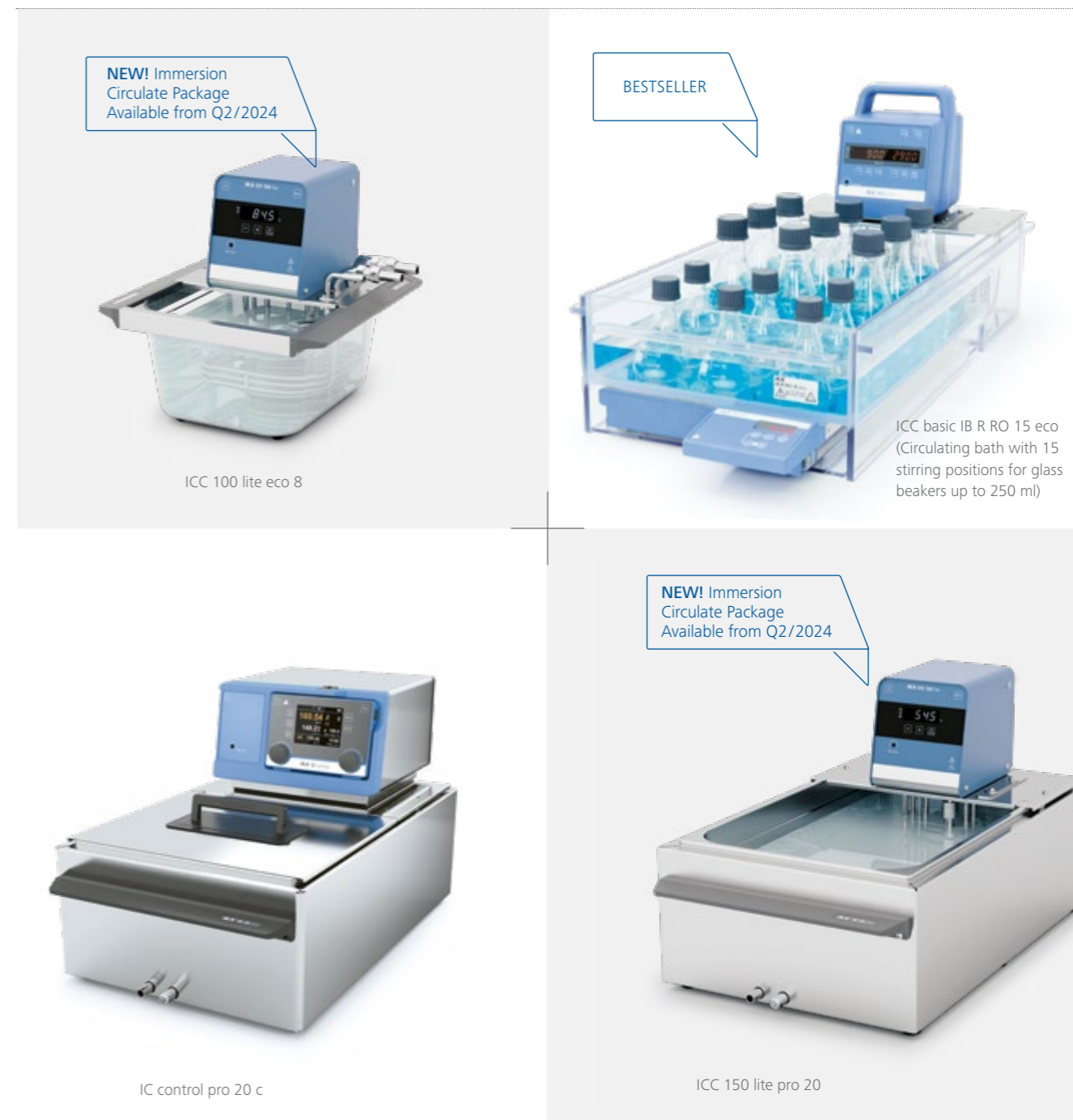

Product	Description	Bath size	Bath opening (W x D)*	Ident. No.	Price
COMBINED HEATING BATH CIRCULATORS					
IC basic pro 12 c	Package IC basic, 12 l pro bath, cover	M	255 x 80 mm	0008039900	EUR 4.304,00
IC basic pro 20 c	Package IC basic, 20 l pro bath, cover	L	255 x 262 mm	0008036800	EUR 4.477,00
IC control pro 12 c	Package IC control, 20 l pro bath, cover	M	255 x 80 mm	0008040000	EUR 4.986,00
IC control pro 20 c	Package IC control, 12 l pro bath, cover	L	255 x 262 mm	0008037200	EUR 5.159,00

* Size of plate that can be placed at the bottom of the bath

/// HEATING BATH CIRCULATORS

- ① **HBC 5 basic**
EUR 3.759,00
Ident. No. 0004125000
- ② **HBC 5 control**
EUR 4.837,00
Ident. No. 0004127000
- ③ **HBC 10 basic**
EUR 4.018,00
Ident. No. 0004135000
- ④ **HBC 10 control**
EUR 5.096,00
Ident. No. 0004137000



/// REFRIGERATED AND HEATING BATH CIRCULATORS

- ① **CBC 5 basic**
EUR 5.679,00
Ident. No. 0004165000
- ② **CBC 5 control**
EUR 6.773,00
Ident. No. 0004167000



/// REFRIGERATED AND HEATING CIRCULATORS

- ① **HRC 2 basic**
EUR 4.424,00
Ident. No. 0025003742
- ② **HRC 2 control**
EUR 5.891,00
Ident. No. 0025004524



/// REFRIGERATED AND HEATING CIRCULATOR

- HRC 2 lite**
EUR 2.899,00
Ident. No. 0020104311



TECHNICAL DATA	HBC 5 BASIC CONTROL HBC 10 BASIC CONTROL	CBC 5 BASIC CONTROL	HRC 2 BASIC CONTROL	HRC 2 LITE
Appliance type	Heated bath circulator	Refrigerated and heating bath circulator	Refrigerated and heating bath circulator	Refrigerated and heating bath circulator
Temperature range	RT +10 °C* – 250 °C	-25 °C – 200 °C	-20 °C – 100 °C -30 °C** – 100 °C	-10 °C – 100 °C
Heater capacity	2500 W	2500 W	1500 W	1000 W
Filling volume	5 – 7 l 8 – 11 l 5 – 7 l 8 – 11 l	5 – 7 l	1.4 – 4 l	1 – 3.5 l
Cooling capacity at 20 °C	–	350 W	400 W	400 W
Display	LED TFT (wireless)	LED TFT (wireless)	LED TFT (wireless)	LED
Temperature stability DIN 12876	± 0.02 K ± 0.01 K	± 0.02 K ± 0.01 K	± 0.1 K ± 0.05 K	± 0.1 K
Max. flow rate	31 l/min	31 l/min	21 l/min	18 l/min
Max. pump pressure/suction	0.61 bar / 0.45 bar	0.61 bar / 0.45 bar	0.5 bar / 0.25 bar	0.35 / 0.15 bar
Dimensions (W x H x D)	275 x 406 x 500 mm 275 x 456 x 500 mm	275 x 690 x 490 mm	220 x 475 x 525 mm	225 x 385 x 430 mm

* Possible operating temperatures with cooling coil: -20 °C to 250 °C
** -30 °C possible at 2000 rpm

/// RECIRCULATING CHILLER

- RC 2 lite**
EUR 2.529,00
Ident. No. 0025006624



- ① **RC 2 basic**
EUR 3.940,00
Ident. No. 0004171000
- ② **RC 2 control**
EUR 5.017,00
Ident. No. 0004173000



BESTSELLER

- ① **RC 2 GREEN basic**
EUR 4.255,00
Ident. No. 0025004186
- ② **RC 2 GREEN control**
EUR 5.616,00
Ident. No. 0025006638



- ① **RC 5 basic**
EUR 5.560,00
Ident. No. 0004181000
- ② **RC 5 control**
EUR 6.755,00
Ident. No. 0004183000



TECHNICAL DATA	RC 2 LITE	RC 2 BASIC CONTROL	RC 2 GREEN BASIC CONTROL	RC 5 BASIC CONTROL
Appliance type	Recirculating chiller	Recirculating chiller	Recirculating chiller	Recirculating chiller
Cooling fluid	R290	R134a	R290	R290
Cooling capacity at 20 °C	400 W	400 W	800 W	1400 W
Temperature range	-10 °C – RT	-20 °C – RT -30 °C – RT	-30 °C – RT	-30 °C – RT
Display	LED	LED TFT (wireless)	LED TFT (wireless)	LED TFT (wireless)
Temperature stability DIN 12876	± 0.5 K	± 0.1 K ± 0.05 K	± 0.15 K	± 0.2 K ± 0.1 K
Max. flow rate	18 l/min	18 l/min	21 l/min	31 l/min
Max. pump pressure	0.35 bar	0.3 bar	0.5 bar	0.61 bar
Min. suction pressure	0.15 bar	0.2 bar	0.25 bar	0.45 bar
Dimensions (W x H x D)	225 x 385 x 430 mm	220 x 475 x 525 mm	220 x 475 x 525 mm	310 x 546 x 490 mm



CS.ICC

CL.ICC



BS.ICC

PCS.ICC



BS.IC

CC1



IB R 9 eco

IB 18 eco



IB 9 pro

IB 20 pro

Product	Description	Ident. No.	Price
ACCESSORIES FOR ICC			
CS.ICC	Cover, small for ICC, 8 / 9 l bath vessels	0004471500	EUR 157,00
CM.ICC	Cover, medium for ICC, 12 l bath vessels	0025000290	EUR 196,00
CL.ICC	Cover, big for ICC, 18 / 20 l bath vessels	0004471600	EUR 223,00
CLG.ICC	Gable lid for ICC, bath size L	0020023680	EUR 637,00
CLR.ICC	Cover with 6 ring openings for ICC, 18/20 l bath vessels	0025006276	EUR 327,00
BS.ICC	Bridge, small for ICC, 8 / 9 l bath vessels	0020003077	EUR 157,00
BL.ICC	Bridge, big for ICC, 18 / 20 l bath vessels	0020003078	EUR 164,00
BS.ICC lite	Bridge, small for ICC lite, 8/9 l bath vessels	0020119539	EUR 164,00
BL.ICC lite	Bridge, big for ICC lite, 8/9 l bath vessels	0020119540	EUR 157,00
CC2	Cooling coil for ICC	0025001061	EUR 157,00
PCS.ICC	Pump connection set for ICC	0004471900	EUR 184,00

Product	Description	Ident. No.	Price
ACCESSORIES FOR IC			
CM.IC	Cover, medium for IC, 12 l bath vessels	0004577600	EUR 161,00
CL.IC	Cover, big for IC, 18 / 20 l bath vessels	0004471800	EUR 214,00
BS.IC	Bridge, small for IC, 12 / 18 / 20 l bath vessels	0004472800	EUR 161,00
CC1	Cooling coil for IC basic / control	0020005116	EUR 168,00

Product	Description	Ident. No.	Price
BATH VESSELS			
Bath size S			
IB 8 eco	Bath vessel, plastic, 8 l	0004248100	EUR 429,00
IB R 9 eco	Bath vessel, plastic, 9 l, rectangular	0020004382	EUR 456,00
IB 9 pro	Bath vessel, stainless steel, 9 l	0004248500	EUR 612,00

Product	Description	Ident. No.	Price
Bath size M			
IB 12 pro	Bath vessel, stainless steel, 12 l	0004577500	EUR 689,00

Product	Description	Ident. No.	Price
Bath size L			
IB 18 eco	Bath vessel, plastic, 18 l	0004248200	EUR 598,00
IB HF 24 eco	Bath vessel, plastic, 24 l	0020006884	EUR 676,00
IB R 20 eco	Bath vessel, 20 l, plastic, rectangular	0020004383	EUR 598,00
IB R 52 eco	Bath vessel, 52 l, plastic, rectangular	0020007044	EUR 845,00
IB R RO 15 eco	Bath vessel for magn. stirrer RO 15	0020006341	EUR 1.025,00
IB R RO 15 pro	Bath vessel for magn. stirrer RO 15	0025007761	EUR 2.013,00
IB 20 pro	Bath vessel, stainless steel, 20 l	0004248600	EUR 818,00



HF.Si.20.200.50



LT 5.32



H.SI.8



H.FKM.12.ISO



ISO.8



ISO.12

Product	Description	Ident. No.	Price
THERMOFLUIDS			
HF.Si.20.250.50A	Heating fluid Si250A; 10 kg	0020003521	EUR 624,00
HF.Si.20.200.50	Heating fluid Si200; 10 kg	0020003520	EUR 559,00
UF.Si.N30.150.10LV	Universal fluid Si150 LV; 9 kg	0020003518	EUR 585,00

Product	Description	Ident. No.	Price
HOSES			
LT 5.32	Temperature control hose, 1.6 m	0020113271	EUR 831,00
H.PVC.8	Hose, PVC, Ø 8 mm, 2 x 1.5 m	0004568800	EUR 16,50
H.PVC.12	Hose, PVC, Ø 12 mm, 2 x 1.5 m	0004568900	EUR 20,50
H.SI.6	Hose, silicone, Ø 6 mm, 3 m	0020102324	EUR 33,00
H.SI.8	Hose, silicone, Ø 8 mm, 2 x 1.5 m	0004569000	EUR 41,00
H.SI.12	Hose, silicone, Ø 12 mm, 2 x 1.5 m	0004569100	EUR 48,50
H.PUR.8.R	Tube PUR 90 °C, Ø 8, 2 x 1.5 m, reinforced	0020004612	EUR 72,50
H.PUR.12	Tube PUR 90 °C, Ø 12, 2 x 1.5 m	0020004613	EUR 90,50
H.FKM.8	Tube FKM, Ø 8 mm, -30 – 180 °C, 2 x 1.5 m	0004569200	EUR 366,00
H.FKM.12	Tube FKM, Ø 12 mm, -30 – 180 °C, 2 x 1.5 m, M 16 x 1	0004569300	EUR 482,00
H.FKM.8.ISO	Hose set FKM incl. insulation, Ø 8 mm	0010011653	EUR 399,00
H.FKM.12.ISO	Hose set incl. insulation, FKM, Ø 12 mm	0010011652	EUR 525,00
H.PUR.12.AD	Hose set incl. M 16x1 connection, PUR 90 °C, Ø 12 mm	0010011654	EUR 166,00

Product	Description	Ident. No.	Price
INSULATION FOR HOSES			
ISO.8	Insulation, Ø 8 mm, 2 x 1.5 m	0004569400	EUR 34,00
ISO.12	Insulation, Ø 12 mm, 2 x 1.5 m	0004569500	EUR 43,50



Tube rack, 13 mm, S, stainless



Variable rack, ICC, ML, stainless



Variable bottom, ICC, L, stainless



Bottom plate L



Floating tube rack 1



Floating globes, PP



WH10

Product	Description	Ident. No.	Price
TUBE RACKS			
Tube rack, 13 mm, S, stainless	Stainless steel rack for bath size S, Ø 13 mm	0020004026	EUR 105,00
Tube rack, 17 mm, S, stainless	Stainless steel rack for bath size S, Ø 17 mm	0020004027	EUR 105,00
Tube rack, 22 mm, S, stainless	Stainless steel rack for bath size S, Ø 22 mm	0020004028	EUR 105,00
Tube rack, 13 mm, ML, stainless	Stainless steel rack for bath size M+L, Ø 13 mm	0020004029	EUR 177,00
Tube rack, 17 mm, ML, stainless	Stainless steel rack for bath size M+L, Ø17 mm	0020004030	EUR 177,00
Tube rack, 22 mm, ML, stainless	Stainless steel rack for bath size M+L, Ø 22 mm	0020004031	EUR 177,00
Variable rack, ICC, ML, stainless	Variable rack for bath size M+L.ICC	0020004032	EUR 229,00
Inlay 1, variable rack, ICC, ML	Inlay for variable rack, Ø 13 mm, 2 pcs.	0020004033	EUR 72,50
Inlay 2, variable rack, ICC, ML	Inlay for variable rack, Ø 17 mm, 2 pcs.	0020004034	EUR 72,50
Inlay 3, variable rack, ICC, ML	Inlay for variable rack, Ø 22 mm, 2 pcs.	0020004035	EUR 72,50
Variable bottom, ICC, L, stainless	Variable bottom for bath size L.ICC	0020004614	EUR 500,00
Bottom plate L	Bottom plate for bath size L	0020006212	EUR 546,00
Bottom plate L, ICC	Bottom plate for bath size L.ICC	0020007353	EUR 456,00
FLOATING RACKS			
Floating tube rack 1	Floating tube rack for 24 x 1.5 / 2.0 ml tubes, 5 pcs.	0020003667	EUR 42,00
Floating tube rack 2	Floating tube rack for 8 x 15 ml tubes, 5 pcs.	0020003668	EUR 42,00
Floating tube rack 3	Floating tube rack for 4 x 50 ml tubes, 5 pcs.	0020003669	EUR 42,00
ADDITIONAL ACCESSORIES			
WH10	WiCo Holder	0020000984	EUR 27,50
PT 100.30	Temp. sensor, stn. steel	0004284700	EUR 371,00
PT 100 extension (Lemo)	Extension cable PT 100, lemo connector, 3 m	0020004629	EUR 229,00
Floating globes, PP	Floating globes, PP, 500 pcs.	0020003666	EUR 139,00
Distribution Pipe	4-sided distributor tube for improved flow in large tanks, stainless steel	0020027440	EUR 176,00
PDS.IB.R.RO	Pump connection set ICC for IB R RO baths, incl. distribution pipe	0020026449	EUR 252,00



CO V 1



Ball valve M16x1



Mechanic fluid level controller



Elbow tube 90°



Olive for DN 6 hoses



Adapter NTP 1/4



Adapter NTP 3/4

Product	Description	Ident. No.	Price
VALVES AND LEVEL CONTROLLERS			
MV 1	Magnetic valve for cooling water control, max. 100 °C	0020003763	EUR 495,00
CO V 1	Closed pressure valve for external pump connection set, max. 180 °C	0020000249	EUR 728,00
Ball valve M16 x 1	Ball valve, completely opening (M 16 x 1)	0020004620	EUR 109,00
Mechanic fluid level controller	Mechanic fluid level controller	0020004618	EUR 405,00
ADAPTERS			
Elbow tube 90°	Elbow tube 90°	0025001212	EUR 98,00
Elbow Olive 90° for pump	90° tube adapter for pump mounting	0025007462	EUR 66,50
Y-hose connector 8 mm	Splitter, PP, max. 135 °C	0020010963	EUR 6,50
Olive for DN 6 hoses	Olive for DN 6 hoses, 2 pcs.	0020004667	EUR 35,00
Olive for DN 8 hoses	Olive for DN 8 hoses, 2 pcs.	0020004566	EUR 35,00
Olive for DN 10 hoses	Olive for DN 10 hoses, 2 pcs.	0020004568	EUR 35,00
Olive for DN 12 hoses	Olive for DN 12 hoses, 2 pcs.	0020004889	EUR 35,00
Adapter NTP 1/4	Adapter M 16 to NPT 1/4, 2 pcs.	0020004569	EUR 54,00
Adapter NTP 1/2	Adapter M 16 to NPT 1/2, 2 pcs.	0020004570	EUR 164,00
Adapter NTP 3/4	Adapter M 16 to NPT 3/4, 2 pcs.	0020004571	EUR 196,00
Adapter M16 x 1 f - G1/4 m	Adapter M 16 x 1 female to G 1/4 male	0020008807	EUR 118,00
Adapter M16 x 1 m - G1/4 m	Adapter M 16 x 1 male to G 1/4 male	0020008734	EUR 61,00
Adapter M16 x 1 m - G1/2 m	Adapter M 16 x 1 male to G 1/2 male	0020008796	EUR 61,00
Adapter M16 x 1 f - G1/2 m	Adapter M 16 x 1 female to G 1/2 male	0020008800	EUR 118,00
Adapter M16 x 1 f - G3/8 m	Adapter M 16 x 1 female to G 3/8 male	0020008730	EUR 118,00
Adapter M16 x 1 m - G3/8 m	Adapter M 16 x 1 male to G 3/8 male	0020008754	EUR 61,00
Adapter M16 x 1 m - M 16 x 1 m	Adapter M 16 x 1 male to M 16 x 1 male, for hose extension	0025007118	EUR 61,00
Lock nut	Lock nut, 2 pcs.	0020004583	EUR 41,00
Stopper	Stopper, 2 pcs.	0020004584	EUR 41,00

IKA has a diverse range of dry block heaters designed to accommodate various interchangeable heating blocks. They provide precise temperature control for reproducible results. These digital block heaters are ideal for melting and boiling point determination, enzyme reactions, incubation and activation of cultures, immunoassays, DNA denaturation, culture media tests, coagulation tests, blood urea nitrogen determinations and in situ hybridizations.

DRY BLOCK HEATERS

/// Provide precise temperature control in small vessels



Digital block heaters for up to four aluminium blocks provide precise temperature control in small vessels. Included PT 1000 temperature sensor allows temperature control directly in the sample vessel. It is used with PCR tubes, PCR strips, Greiner tubes, microplates and cuvettes. The digital dry block heaters with precisely designed blocks ensure highly accurate and reproducible results, guaranteeing short heating times. The bright, easy to read LED display facilitates very easy setting of the required temperature and accurate monitoring of the actual temperature. Excellent temperature uniformity and stability is ensured.

TIMER

Countdown, adjustable from 1 min to 99 h 59 min.

FIXED SAFETY CIRCUIT

ACCESSORIES

Highly versatile with a large number of blocks.

Dry Block Heater 1

EUR 1.175,00

Ident. No. 0004025100



Dry Block Heater 2

EUR 1.435,00

Ident. No. 0004025200



Dry Block Heater 3

EUR 1.682,00

Ident. No. 0004025300



Dry Block Heater 4

EUR 1.940,00

Ident. No. 0004025400



TECHNICAL DATA

	DRY BLOCK HEATER 1	DRY BLOCK HEATER 2	DRY BLOCK HEATER 3	DRY BLOCK HEATER 4
Number of blocks	1	2	3	4
Heat output	165 W	250 W	330 W	412 W
Heating temperature range	RT +5 °C – 120 °C	RT +5 °C – 120 °C	RT +5 °C – 120 °C	RT +5 °C – 120 °C
Connection for ext. temperature sensor	CT (DIN 12878)	CT (DIN 12878)	CT (DIN 12878)	CT (DIN 12878)
Temperature homogeneity at 37 / 60 °C	0.2 K / 0.4 K	0.2 K / 0.4 K	0.3 K / 0.6 K	0.3 K / 0.6 K
Set-up plate dimensions	96 × 76 mm	96 × 152 mm	96 × 228 mm	96 × 304 mm
Dimensions (W × H × D)	151 × 73 × 228 mm	151 × 73 × 304 mm	151 × 73 × 380 mm	151 × 73 × 456 mm
Protection class according to DIN EN 60529	IP 21	IP 21	IP 21	IP 21



DB 1.1



DB 3.2



DB 4.6



DB 4.6



DB 5.2



DB 5.8



DB 8.1

Product	Description	Ident. No.	Price
MICRO CENTRIFUGE TUBES			
DB 1.1	Single block, PCR tubes, Ø 7.9 mm	0004467600	EUR 130,00
DB 1.2	Single block, Eppendorf tubes, Ø 11.5 mm	0004467700	EUR 130,00
DB 1.3	Single block, microtubes, Ø 11.1 mm	0004467800	EUR 130,00
DB 1.4	Single block, VWR Eppendorf tubes, Ø 10.9 mm	0004467900	EUR 130,00
DB 1.5	Single block, corning tubes, Ø 10.9 mm	0004468000	EUR 130,00

Product	Description	Ident. No.	Price
CONICAL BOTTOM CENTRIFUGE TUBES			
DB 2.1	Single block, conical tubes, Ø 17.1 mm	0004468100	EUR 130,00
DB 2.2	Single block, conical tubes, Ø 29 mm	0004468200	EUR 130,00

Product	Description	Ident. No.	Price
COMBINATION BLOCKS			
DB 3.1	Single block, test tube comb., 6 12 13 25 mm	0004468300	EUR 130,00
DB 3.2	Single block, centrifuge comb., 1.5 15 50 ml	0004468400	EUR 130,00
DB 3.3	Single block, microtube comb., 0.5 1.5 2 ml	0004468500	EUR 130,00

Product	Description	Ident. No.	Price
STANDARD TEST TUBES			
DB 4.1	Single block, 30 round tubes, Ø 8.3 mm	0004468600	EUR 137,00
DB 4.2	Single block, 24 round tubes, Ø 10.7 mm	0004468700	EUR 137,00
DB 4.3	Single block, 16 round tubes, Ø 13.9 mm	0004468800	EUR 137,00
DB 4.4	Single block, 20 round tubes, Ø 13.9 mm	0004468900	EUR 137,00
DB 4.5	Single block, 12 round tubes, Ø 17.5 mm	0004469000	EUR 137,00
DB 4.6	Single block, 8 round tubes, Ø 21 mm	0004469100	EUR 137,00
DB 4.7	Single block, 6 round tubes, Ø 26.2 mm	0004469200	EUR 137,00
DB 4.8	Single block, 4 round tubes, Ø 35 mm	0004469300	EUR 137,00
DB 4.9	Single block, 12 round tubes, Ø 19.1 mm	0004469400	EUR 137,00

Product	Description	Ident. No.	Price
VIALS			
DB 5.1	Single block, 12 mm vials, Ø 12.7 mm	0004469500	EUR 137,00
DB 5.2	Single block, 15 mm vials, Ø 15.8 mm	0004469600	EUR 137,00
DB 5.3	Single block, 17 mm vials, Ø 17.8 mm	0004469700	EUR 137,00
DB 5.4	Single block, 19 mm vials, Ø 19.7 mm	0004469800	EUR 137,00
DB 5.5	Single block, 21 mm vials, Ø 21.7 mm	0004469900	EUR 137,00
DB 5.6	Single block, 23 mm vials, Ø 23.8 mm	0004470000	EUR 137,00
DB 5.7	Single block, 25 mm vials, Ø 25.8 mm	0004470100	EUR 137,00
DB 5.8	Single block, 28 mm vials, Ø 28.8 mm	0004470200	EUR 137,00
DB 5.9	Single block, 16 mm vials, Ø 16.4 mm	0004470300	EUR 137,00

Product	Description	Ident. No.	Price
STANDARD TEST TUBES			
DB 6.1	Single block, 10 × 8 PCR tube strips, Ø 6.4 mm	0004470400	EUR 130,00
DB 6.2	Single block, 64 PCR tubes, Ø 6.4 mm	0004470500	EUR 130,00
DB 6.3	Double block, 1 × 96-Well PCR plate, Ø 6.4 mm	0004470600	EUR 315,00
DB 7.1	Double block, 96- or 384-Well-plate	0004470800	EUR 189,00
DB 8.1	Single block, 2 × 6 cuvettes, Ø 12.5 mm	0004470700	EUR 130,00

Product	Description	Ident. No.	Price
TEMPERATURE SENSORS			
PT 1000.60	Temp. sensor, stn. steel, Ø 3 mm, depth: 230 mm	0003516800	EUR 157,00
PT 1000.90	Temp. sensor, coated, Ø 3 mm, depth: 230 mm	0004480600	EUR 222,00

C-MAG HP 4
EUR 523,00
Ident. No. 0003581600



C-MAG HP 7
EUR 685,00
Ident. No. 0003581800



C-MAG HP 10
EUR 936,00
Ident. No. 0003582000



TECHNICAL DATA	C-MAG HP 4	C-MAG HP 7	C-MAG HP 10
Heat output	250 W	1000 W	1500 W
Heating temperature range	50 °C – 500 °C	50 °C – 500 °C	50 °C – 500 °C
Connection for ext. temperature sensor	–	ETS-D5	ETS-D5
Heating rate heating plate	2.5 K / min	5 K / min	5 K / min
Set-up plate material	Ceramic	Ceramic	Ceramic
Set-up plate dimensions	100 × 100 mm	180 × 180 mm	260 × 260 mm
Dimensions (W × H × D)	150 × 105 × 260 mm	220 × 105 × 330 mm	300 × 105 × 415 mm
Protection class according to DIN EN 60529	IP 21	IP 21	IP 21

IKA heating baths are developed with a strong focus on safety. All baths are equipped with a double jacket to protect against burns and a safety temperature monitor prevents overheating of the bath. After turning on the unit, the safety functions are automatically checked.

HB DIGITAL

/// Enlarged volume

The universal heating bath HB digital has a volume of 4 liters and is especially designed to work with our rotary evaporators. Apart from that, the unit can be operated as a stand-alone device for applications within preparative chemistry.

It is easily operated by a push-button and a key switch locks temperature settings to prevent unintentional adjustments. Due to its ergonomic handles the device can be moved effortlessly within the laboratory. Its safety circuit is adjustable.

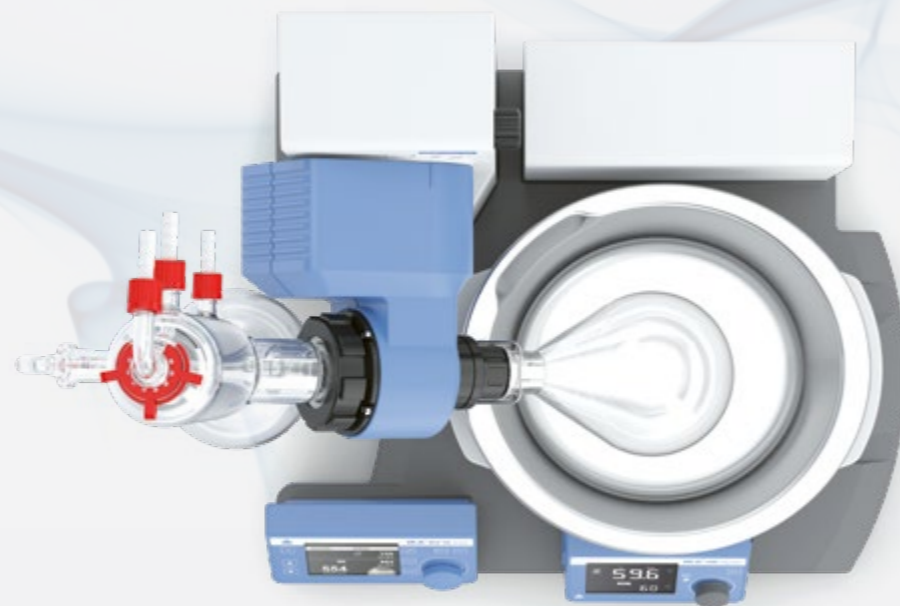

HB eco

EUR 1.362,00

Ident. No. 0020016337



HB digital

EUR 1.699,00

Ident. No. 0020016334



Heating temperature up to 180 °C

HBR 4 control

EUR 4.573,00

Ident. No. 0020003549

Integrated magnetic stirrer drive



Product	Ident. No.	Price
ACCESSORIES HB ECO DIGITAL		
HB 10.3 Protection cover HB eco and digital	0020024125	EUR 980,00
ACCESSORIES HBR 4 CONTROL		
H 240 Ring set	0002858700	EUR 642,00
H 159 Intermediate bottom	0001809700	EUR 294,00

TECHNICAL DATA	HB ECO DIGITAL	HBR 4 CONTROL
Heating temperature max.	99 °C 180 °C	200 °C
Filling volume max.	4 l	4 l
Filling point min.	60 mm	20 mm
Heat output	1400 W	1000 W
Safety circuit	109 °C 50 – 190 °C	50 – 210 °C
Display	LED / LCD	LCD
Inner diameter	225 mm	200 mm
Dimensions (W x H x D)	330 x 190 x 325 mm	340 x 250 x 340 mm
Protection class according to DIN EN 60529	IP 21	IP 20



HB 10.3

Heat on a grand scale: Our drying ovens handle the particularly powerful tempering and drying. Our incubators ensure ideal growth conditions for cell cultures. All devices are known for their precision. And if you wish, your samples can also be shaken – in our new incubation shaker.

INC 125 FS DIGITAL

/// Incubator shaker with patented removable shaker platform



▶ Watch IKA INC video



Its removable shaker platform is patented: The INC 125 FS digital accommodates three additional grid shelves for incubation in addition to the shaker platform. If the platform is removed, six wire grid trays fit into the 125-liter interior. It can then be used like a normal incubator.

INC 125 FS digital is particularly suitable for applications in the life sciences: for microbiological tests, stability studies or cell cultivation.

ERGONOMIC

The shaker platform can be easily removed, for example, to attach retaining clamps quickly and ergonomically. If you then push the platform into the illuminated incubator up to the mark, it sits tilt-proof and can be filled conveniently.

EASY TO CLEAN

The inner chamber is made of corrosion-resistant AISI 304 material, and thanks to the removable shaker platform, INC 125 FS digital has fewer dead spots. Added to this is its practical drip tray which helps to catch sample spills. Altogether, this makes cleaning the incubator shaker much faster and easier. And to avoid cross-contamination, a decontamination mode is available for disinfection purpose.

PRECISE

INC 125 FS digital enables precise temperature control in the range from +8°C to +80°C and homogeneous temperature distribution. Temperature stability is excellent at +/- 0.1°C. After opening the door, the temperature quickly returns to the desired level. This is due to the fact that preheated air is supplied. In addition, the good insulation and recirculation mode help save energy.

/// INCUBATOR

INC 125 F digital

EUR 2.099,00

Ident. No. 0020117172



/// INCUBATOR SHAKER

INC 125 FS digital (SP20)

EUR 5.199,00

Ident. No. 0020117221

INC 125 FS digital (SP25)

EUR 5.199,00

Ident. No. 0020117230



TECHNICAL DATA

	INC 125 F DIGITAL	INC 125 FS DIGITAL (SP20) (SP25)
Type	Incubator	Incubator shaker
Total volume inner chamber	125 l	125 l
Working temperature	RT+ 8 °C – 100 °C	RT+ 8 °C – 80 °C
Heat output	750 W	750 W
Temperature stability	± 0.3 K	± 0.1 K
Temperature safety class (DIN 12880)	TB class 1	TB class 1
Interior lighting	No	Yes
Decontamination mode	Yes (120 °C)	Yes (100 °C/120 °C)
Speed range	–	10 – 300 rpm
Shaking stroke	–	20 mm 25 mm
Dimensions (W x H x D)	700 x 720 x 635 mm	700 x 720 x 635 mm

① Oven 125 basic - dry

EUR 2.351,00
Ident. No. 0020003215

② Oven 125 basic - dry glass

EUR 2.823,00
Ident. No. 0020003956



① Oven 125 control - dry

EUR 3.869,00
Ident. No. 0020003990

② Oven 125 control - dry glass

EUR 4.354,00
Ident. No. 0020003996



TECHNICAL DATA	OVEN 125 BASIC (DRY DRY GLASS)	OVEN 125 CONTROL (DRY DRY GLASS)
Principle of heat transfer	Natural convection	Forced convection (fan adjustable in 10 steps)
Total volume inner chamber	125 l	125 l
Working temperature	RT +5 °C – 250 °C	RT +5 °C – 300 °C
Heat output	2400 W	2400 W
Temperature Safety Class (DIN 12880)	TB (Class 1)	TB (Class 1); TWB (Class 2)
Data logging function	No	Yes
Cable access port	No	Yes
Interior lighting	No	Yes
PT 100 interface	No	Yes
Protection class according to DIN EN 60529	IP 20	IP 20
Dimensions (W x H x D)	700 x 825 x 650 mm	700 x 825 x 650 mm

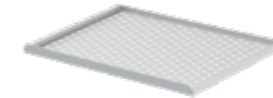

IO T 2.20

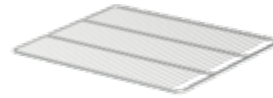

IO T 2.10

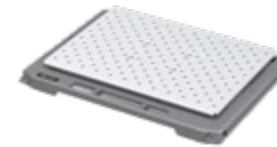

IO SP 20 / IO SP 25



AS 2.1 AS 2.4



IO F 1.20



IO B 1.10

Product	Description	Ident. No.	Price
ACCESSORIES FOR INC 125 INCUBATOR AND INCUBATOR SHAKER			
IO T 2.20	Perforated tray	0020118202	EUR 58,00
IO T 2.10	Wire grid tray	0020118621	EUR 126,00
IO S 2.10	Stacking kit	0020118174	EUR 63,00
Service - changing of door opening direction		0010012073	EUR 157,00

ACCESSORIES FOR INC 125 F DIGITAL INCUBATOR			
IO L 2.10	Door lock	0035004372	EUR 104,00

ACCESSORIES FOR INC 125 FS DIGITAL INCUBATOR SHAKER			
IO SP 20	Shaker platform with 20 mm shaking stroke	0035004555	EUR 1.994,00
IO SP 25	Shaker platform with 25 mm shaking stroke	0020117011	EUR 1.994,00
IO T 2.30	Drip pan	0020118266	EUR 114,00
STICKMAX	Universal adhesive mat	0003920000	EUR 65,00
AS 2.0	Fixing clips, 10 ml	0020016475	EUR 59,00
AS 2.1	Fixing clips, 25 ml	0001234300	EUR 31,50
AS 2.2	Fixing clips, 50 ml	0001234400	EUR 31,50
AS 2.3	Fixing clips, 100 ml	0001234500	EUR 31,50
AS 2.4	Fixing clips, 200 / 250 ml	0001234600	EUR 59,00
AS 2.5	Fixing clips, 500 ml	0001234700	EUR 59,00
AS 2.6	Fixing clips, 1000 ml	0003819300	EUR 59,00
AS 2.7	Fixing clips, 2000 ml	0020016476	EUR 83,00

ACCESSORIES FOR OVEN			
IO F 1.20	Spacer frame	0035001326	EUR 559,00
PT 100.31	Temp. sensor, stn. steel, Ø6 mm, 265 mm	0020009564	EUR 360,00

ACCESSORIES FOR ALL TEMPERING CHAMBERS			
IO T 1.00	Wire grid tray, chrom plated	0020024935	EUR 157,00
IO T 1.10	Enhanced wire grid tray	0020007600	EUR 275,00
IO F 1.10	Roller frame	0020007601	EUR 975,00
IO B 1.10	Roller box	0020007602	EUR 1.117,00
IO P 1.10	Table top work plate	0020007603	EUR 1.038,00

This separation will be easy for you. Because the IKA RV 3, RV 8, RV 10 digital, RV 10 auto and RV 10 auto pro rotary evaporators set new standards in distillation. They are particularly safe, economical and user-friendly. They owe this to state-of-the-art technology and innovative design. And now there is also a complete solution for your rotary evaporator setup: RV 10 auto pro V-C Complete.



> Check
RV Configurator

RV 10 AUTO PRO V-C COMPLETE

/// Complete solution for your setup

In addition to the RV 10 auto pro rotary evaporator, this package includes the HB digital heating bath with a capacity of 4 liters, the VACSTAR digital vacuum pump and the RC 2 lite recirculating chiller. So everything you need for operation is already included.

THE FLAGSHIP FOR DISTILLING

The RV 10 auto pro rotary evaporator impresses with intuitive operation, an integrated vacuum controller, automatic vacuum control, cooling water monitoring and sophisticated safety standards. It is efficient, economical and safe in operation. Its innovative features include the patented volume-controlled distillation, soft start, interval operation and the timer function.

THE MOST COMPACT COOLER

400 watts cooling capacity and a pump pressure of 0.35 bar: The package includes the new compact RC 2 lite recirculating chiller. It focuses on the essentials in every respect. This makes it space-saving, powerful, economical and the perfect complement to the rotary evaporator.

THE SPACE SAVING VACUUM PUMP

The VACSTAR digital vacuum pump included in the package is extremely space-saving and achieves a minimum vacuum of 2 mbar. It is controlled directly from the RV 10 auto drive unit via the supplied data cable and automatically detects the boiling points. The vacuum safety emission condenser VSE 1 ensures special safety.

- | | | | |
|--|---|--|--|
| ① RV 3 V
EUR 2.829,00
Ident. No. 0010003324 | ⑥ RV 3 pro V Complete
EUR 8.293,00
Ident. No. 0010011410 | ① RV 8 V
EUR 3.523,00
Ident. No. 0010003482 | ⑥ RV 8 pro V Complete
EUR 9.980,00
Ident. No. 0010011411 |
| ② RV 3 V-C
EUR 3.016,00
Ident. No. 0010003328 | ⑦ RV 3 pro V-C Complete
EUR 8.714,00
Ident. No. 0010012324 | ② RV 8 V-C
EUR 3.721,00
Ident. No. 0010003485 | ⑦ RV 8 pro V-C Complete
EUR 10.401,00
Ident. No. 0010012325 |
| ③ RV 3 FLEX
EUR 2.553,00
Ident. No. 0010003331 | | ③ RV 8 FLEX
EUR 3.335,00
Ident. No. 0010003488 | |
| ④ RV 3 Dry Ice Condenser
EUR 3.410,00
Ident. No. 0010006363 | | ④ RV 8 Dry Ice Condenser
EUR 4.105,00
Ident. No. 0010006361 | |
| ⑤ RV 3 Dry Ice Condenser, coated
EUR 3.600,00
Ident. No. 0010006362 | | ⑤ RV 8 Dry Ice Condenser, coated
EUR 4.302,00
Ident. No. 0010006360 | |



TECHNICAL DATA	RV 3	RV 8
Motor type	Brushless DC drive motor	Brushless DC drive motor
Speed range	20 – 300 rpm	5 – 300 rpm
Speed display	Scale	Digital
Heating temperature range	RT – 99 °C	RT – 180 °C
Type of cooling	Vertical	Vertical
Cooling surface	1600 cm ²	1600 cm ²
Soft start	Yes	Yes
Head angle adjustable	0 to 60 °	0 to 45 °
Stroke displacement	150 mm, manual	120 mm, manual
Vacuum controller	Optional	Optional
Dimensions (W × H × D) without glass parts	440 × 530 × 330 mm	510 × 490 × 345 mm
Protection class acc. to DIN EN 60529	IP 20	IP 20

OUR PACKAGES

V: vertical glassware
V-C: vertical glassware with special plastic coating
FLEX: no glassware included
Complete: vacuum pump, controller and chiller included

Further package
information on
page 170

- ① **RV 10 digital V**
EUR 5.313,00
Ident. No. 0010004799
- ② **RV 10 digital V-C**
EUR 5.759,00
Ident. No. 0010004802
- ③ **RV 10 digital FLEX**
EUR 5.100,00
Ident. No. 0010004805
- ④ **RV 10 digital Dry Ice Condenser**
EUR 5.895,00
Ident. No. 0010006365
- ⑤ **RV 10 digital Dry Ice Condenser, coated**
EUR 6.339,00
Ident. No. 0010006364
- ⑥ **RV 10 digital pro V Complete**
EUR 11.031,00
Ident. No. 0010011963
- ⑦ **RV 10 digital pro V-C Complete**
EUR 11.452,00
Ident. No. 0010012326



TECHNICAL DATA	RV 10 DIGITAL
Motor type	Brushless DC drive motor
Speed range	5 – 280 rpm
Clockwise and counter-clockwise	Yes
Heating temperature range	RT – 180 °C
Type of cooling	Vertical
Cooling surface	1600 cm ²
Filling volume max.	4 l
Soft start	Yes
Head angle adjustable	0 to 45°
Stroke displacement	140 mm, motorized
Setting of lower end stop	60 mm, contact free
Vacuum controller	Optional
Dimensions (W × H × D) without glass parts	500 × 430 × 440 mm
Protection class acc. to DIN EN 60529	IP 20



- ① **RV 10 auto pro V**
EUR 11.145,00
Ident. No. 0010004815*
- ② **RV 10 auto pro V-C**
EUR 11.566,00
Ident. No. 0010004812*
- ③ **RV 10 auto pro FLEX**
EUR 11.037,00
Ident. No. 0010004818*
- ④ **RV 10 auto pro V-C Complete**
EUR 12.196,00
Ident. No. 0010007353
- ⑤ **RV 10 digital pro V double Complete**
EUR 19.612,00
Ident. No. 0010011964
- ⑥ **RV 10 digital pro V-C double Complete**
EUR 20.454,00
Ident. No. 0010012327

TECHNICAL DATA	RV 10 AUTO PRO
Motor type	Brushless DC drive motor
Speed range	5 – 300 rpm
Speed display	Digital
Clockwise and counter-clockwise	Yes
Heating temperature range	RT – 180 °C
Type of cooling	Vertical
Cooling surface	1600 cm ²
Filling volume max.	4 l
Soft start	Yes
Head angle adjustable	0 to 45°
Stroke displacement	140 mm, motorized
Setting of lower end stop	60 mm, contact free
Vacuum controller	Integrated
Dimensions (W × H × D) without glass parts	500 × 430 × 440 mm
Protection class acc. to DIN EN 60529	IP 20



*Pro packages include VACSTAR digital



RV 10.1

RV 10.1 enlarged surface



RV 10.3

RV 10.4



RV 10.400

RV 10.500



RV 10.600

RV 10.606



RV 10.84

RV 10.301

Product	Description	Ident. No.	Price
ACCESSORIES RV 10, RV 8, RV 3			
RV 10.1	Set of glassware, vertical	0003655300	EUR 1.038,00
RV 10.10	Set of glassware, vertical, coated	0003755400	EUR 1.459,00
RV 10.11 enlarged surface	Vertical-condenser, enlarged surface	0020019652	EUR 1.280,00
RV 10.100 enlarged surface	Vertical-condenser, coated, enlarged surface	0020019654	EUR 1.546,00
RV 10.2	Set of glassware, diagonal	0003755300	EUR 1.073,00
RV 10.20	Set of glassware, diagonal, coated	0003755500	EUR 1.485,00
RV 10.3	Vertical-intensive condenser, manifold	0003741000	EUR 1.249,00
RV 10.30	Vertical-intensive condenser, manifold, coated	0003741100	EUR 1.709,00
RV 10.4	Dry ice condenser	0003742000	EUR 1.258,00
RV 10.40	Dry ice condenser, coated	0003742100	EUR 2.008,00
RV 10.5	Vertical-condenser, reflux	0003743000	EUR 2.007,00
RV 10.50	Vertical-condenser, reflux, coated	0003743100	EUR 2.200,00
RV 10.6	Vertical-intensive condenser, reflux	0003744000	EUR 2.203,00
RV 10.60	Vertical-intensive condenser, reflux, coated	0003744100	EUR 2.401,00
RV 05.10	Balljoint clamp	0000736600	EUR 25,50
RV 10.88	Clamp, NS 29	0003683300	EUR 25,50
RV 10.400	Evaporation cylinder, NS 29/32, 500 ml	0003738800	EUR 819,00
RV 10.401	Evaporation cylinder, NS 29/32, 1500 ml	0003738900	EUR 937,00
RV 10.500	Foam brake, NS 29/32	0003739200	EUR 174,00
RV 10.600	Distilling spider, NS 29/32, 6 sleeves	0003739400	EUR 702,00
RV 10.601	Distilling spider, NS 29/32, 12 sleeves	0003739500	EUR 1.174,00
RV 10.602	Distilling spider, NS 29/32, 20 sleeves	0003739600	EUR 1.645,00
RV 10.610	Distilling sleeve, 20 ml	0003919400	EUR 20,50
RV 10.606	Distilling spider with 5 flasks, 50 ml	0003740800	EUR 856,00
RV 10.607	Distilling spider with 5 flasks, 100 ml	0003740900	EUR 938,00
RV 10.80	Evaporation flask, NS 29/32, 50 ml	0003740100	EUR 42,00
RV 10.800	Evaporation flask, coated, NS 29/32, 50 ml	0020005330	EUR 83,00
RV 10.81	Evaporation flask, NS 29/32, 100 ml	0003740200	EUR 42,00
RV 10.810	Evaporation flask, coated, NS 29/32, 100 ml	0020005331	EUR 83,00
RV 10.82	Evaporation flask, NS 29/32, 250 ml	0003740300	EUR 78,00
RV 10.820	Evaporation flask, coated, NS 29/32, 250 ml	0020005332	EUR 155,00
RV 10.83	Evaporation flask, NS 29/32, 500 ml	0003740400	EUR 82,00
RV 10.830	Evaporation flask, coated, NS 29/32, 500 ml	0020005333	EUR 161,00
RV 10.84	Evaporation flask, NS 29/32, 1000 ml	0003740500	EUR 83,00
RV 10.840	Evaporation flask, coated, NS 29/32, 1000 ml	0004221400	EUR 166,00
RV 10.85	Evaporation flask, NS 29/32, 2000 ml	0003740600	EUR 132,00
RV 10.850	Evaporation flask, coated, NS 29/32, 2000 ml	0020005334	EUR 260,00
RV 10.86	Evaporation flask, NS 29/32, 3000 ml	0003740700	EUR 201,00
RV 10.860	Evaporation flask, coated, NS 29/32, 3000 ml	0020005335	EUR 399,00
RV 10.90	Evaporation flask, NS 24/29, 50 ml	0003741200	EUR 42,00
RV 10.91	Evaporation flask, NS 24/29, 100 ml	0003741300	EUR 42,00

Product	Description	Ident. No.	Price
ACCESSORIES RV 3, RV 8, RV 10			
RV 10.100	Receiving flask, KS 35/20, 100 ml	0003742200	EUR 72,50
RV 10.101	Receiving flask, KS 35/20, 250 ml	0003742300	EUR 75,00
RV 10.102	Receiving flask, KS 35/20, 500 ml	0003742400	EUR 80,00
RV 10.103	Receiving flask, KS 35/20, 1000 ml	0003742500	EUR 83,00
RV 10.104	Receiving flask, KS 35/20, 2000 ml	0003742600	EUR 136,00
RV 10.105	Receiving flask, KS 35/20, 3000 ml	0003742700	EUR 251,00
RV 10.200	Receiving flask, coated, KS 35/20, 100 ml	0003743200	EUR 142,00
RV 10.201	Receiving flask, coated, KS 35/20, 250 ml	0003743300	EUR 147,00
RV 10.202	Receiving flask, coated, KS 35/20, 500 ml	0003743400	EUR 182,00
RV 10.203	Receiving flask, coated, KS 35/20, 1000 ml	0003743500	EUR 214,00
RV 10.204	Receiving flask, coated, KS 35/20, 2000 ml	0003743600	EUR 241,00
RV 10.205	Receiving flask, coated, KS 35/20, 3000 ml	0003743700	EUR 320,00
RV 10.300	Powder flask, NS 29/32, 500 ml	0003738200	EUR 191,00
RV 10.301	Powder flask, NS 29/32, 1000 ml	0003738300	EUR 203,00
RV 10.302	Powder flask, NS 29/32, 2000 ml	0003738400	EUR 250,00
RV 10.70	Vapor tube, NS 29/32	0003812200	EUR 130,00
RV 10.74	Vapor tube, short, NS 29/32	0003971700	EUR 112,00
RV 10.8001	Seal, PTFE, stn. steel	0003907000	EUR 139,00
RV 10.3000	Extension plate	0003859000	EUR 174,00



RV 10.103



RV 10.74



RV 10.8001

RV 10.3000

ACCESSORIES RV 3

RV 3.1	Support pole	0025004587	EUR 130,00
RV 3.4	Woulff bottle	0025004588	EUR 177,00
RV 10.5005	Hose kit	0020000552	EUR 130,00

ACCESSORIES RV 8

RV 8.1	Support pole	0004438500	EUR 130,00
RV 8.2	Mechanical end stop for RV 8	0025001342	EUR 66,50
RV 8.3	Stand pole	0025004707	EUR 143,00
RV 10.5005	Hose kit	0020000552	EUR 130,00

ACCESSORIES VALVE RV 10 AUTO

RV 10.5002	Filter	0003903800	EUR 83,00
RV 10.5003	Pressure regulating valve	0003907100	EUR 261,00



RV 3.1

RV 3.4



RV 10.5002



RV 10.5003

The IKA centrifuges are ideal for applications which do not require ultra high speeds, e.g. micro-filtrations and cell separations. The centrifuges mini G and G-L feature a compact design and a small footprint. As a safety feature, the IKA centrifuges will only operate when the lid is closed.

The clearest display in its class

IKA G-L

/// The universal midi centrifuge

Separating substances at medium rotational speeds: IKA G-L is the ideal midi centrifuge for all types of separation processes such as those found in molecular biology. It can be used with standard 1.5 / 2 ml vessels, as well as with PCR strips. The cover opens automatically at the press of a button.

SAFE USE

The centrifuge is fitted with a metal cover and does not start until it is firmly closed.

STATE-OF-THE-ART DISPLAY

The completely intuitive navigation is carried out through a membrane keypad. This allows an easy setting of speed, rotational speed or programmes.

POWERFUL MOTOR

With a rotational speed of up to 15 700 rpm, the centrifuge is fitted with a high-performance motor.



▶ Watch G-L video

mini G

EUR 352,00

Ident. No. 0003958000*



*Adapters included in delivery

IKA G-L

EUR 1.049,00

Ident. No. 0030000774**



**2 ml rotor set included in delivery

Product	Ident. No.	Price
ACCESSORIES IKA MINI G		
Rotor 4 x HPLC	0020022341	EUR 56,00
ACCESSORIES IKA G-L		
PCR Set	0030001345	EUR 224,00
Adapter PCR tube	0030001346	EUR 10,20
Adapter 0.5 ml tube	0030001347	EUR 10,20
Adapter 0.4 ml tube	0030001334	EUR 10,20
2 ml rotor set	0030001333	EUR 282,00

IKA G-L, PCR Set



TECHNICAL DATA	IKA MINI G	IKA G-L
Capacity	8 x 1.5 / 2.0 ml	12 x 1.5 / 2.0 ml
Centrifugal acceleration	2000 G	16 500 G
Speed range	6000 rpm	800 – 15 700 rpm
Unbalance sensor	No	Yes
Timer	Yes	Yes
Quick stop	Yes	Yes
Cover opening	Automatic	Automatic
Program	No	Yes
RPM/RCF conversion	Manually	Automatically
Dimensions (W x H x D)	155 x 105 x 175 mm	200 x 140 x 280 mm
Weight	1.4 kg	3.9 kg

An ergonomic feel combined with uncompromising precise performance: the single channel pipettes fix and vario and multichannel pipettes multi can be used for many applications in the modern laboratory. Color coding simplifies the rapid selection of a suitable pipette. High impact, UV and chemical resistance ensures that the tip cone provides long-term reliable dosing. IKA PETTE fix, vario and multi are fully autoclavable and can be disassembled without tools, therefore ensuring easy sterilization. This guarantees fault-free, precise and safe operation.



▶ Watch PETTE video

PETTE multi

/// Multichannel pipettes for precise results

PETTE multi: the new multichannel pipette from IKA for easy pipetting in microtiter or deep well plates. Based on the ergonomic PETTE fix and vario single channel pipettes, it combines all the positive features with multiple channels and variable volumes.

ERGONOMIC DESIGN

Just like the proven single channel pipettes, the multichannel pipette is also supplied with three different and interchangeable handles. It therefore fits comfortably in the hand of both right- and left-handed users, small and large hands. Whether volume adjustment or ejection of the pipette tips – thanks to the multifunction knob, all handling can be done effortlessly with one hand.

DURABLE CONSTRUCTION

The tip cone and piston are coated with high-quality diamond-like carbon (DLC) for high chemical resistance and frictionless operation. At the same time, the high-performance pipette has such a minimalist design that it is particularly robust, easy to clean and fully autoclavable. The PETTE series' large mechanical display is conveniently readable at all times. An integrated air space between the cylinder and the mechanics also insulates the pipette so that it does not heat up in the hand.



PETTE multi 8 Channel

- ① **PETTE multi**
8 × 0.5 – 10 µl
EUR 490,00
Ident. No. 0020017943
- ② **PETTE multi**
8 × 10 – 100 µl
EUR 490,00
Ident. No. 0020017944
- ③ **PETTE multi**
8 × 20 – 200 µl
EUR 490,00
Ident. No. 0020017945

PETTE multi 12 Channel

- ④ **PETTE multi**
12 × 0.5 – 10 µl
EUR 561,00
Ident. No. 0020017946
- ⑤ **PETTE multi**
12 × 10 – 100 µl
EUR 561,00
Ident. No. 0020017947
- ⑥ **PETTE multi**
12 × 20 – 200 µl
EUR 561,00
Ident. No. 0020017948

	PETTE multi	MAX. VOLUME TIP
①	8 × 0.5 – 10 µl	10 µl
②	8 × 10 – 100 µl	200 µl
③	8 × 20 – 200 µl	200 µl
④	12 × 0.5 – 10 µl	10 µl
⑤	12 × 10 – 100 µl	200 µl
⑥	12 × 20 – 200 µl	200 µl



- ① **PETTE fix 5 µl**
EUR 162,00
Ident. No. 0020011219
- ② **PETTE fix 10 µl**
EUR 162,00
Ident. No. 0020011220
- ③ **PETTE fix 20 µl**
EUR 162,00
Ident. No. 0020011221
- ④ **PETTE fix 25 µl**
EUR 162,00
Ident. No. 0020011222
- ⑤ **PETTE fix 50 µl**
EUR 162,00
Ident. No. 0020011223
- ⑥ **PETTE fix 100 µl**
EUR 162,00
Ident. No. 0020011224
- ⑦ **PETTE fix 200 µl**
EUR 162,00
Ident. No. 0020011225
- ⑧ **PETTE fix 250 µl**
EUR 162,00
Ident. No. 0020011226
- ⑨ **PETTE fix 500 µl**
EUR 162,00
Ident. No. 0020011227
- ⑩ **PETTE fix 1000 µl**
EUR 162,00
Ident. No. 0020011228

	PETTE FIX	MAX. VOLUME TIP
①	5 µl	10 µl
②	10 µl	10 µl
③	20 µl	200 µl
④	25 µl	200 µl
⑤	50 µl	200 µl
⑥	100 µl	200 µl
⑦	200 µl	200 µl
⑧	250 µl	1000 µl
⑨	500 µl	1000 µl
⑩	1000 µl	1000 µl



- ① **PETTE vario 0.1 – 2 µl**
EUR 244,00
Ident. No. 0020011210
- ② **PETTE vario 0.5 – 10 µl**
EUR 244,00
Ident. No. 0020011211
- ③ **PETTE vario 2 – 20 µl**
EUR 244,00
Ident. No. 0020011213
- ④ **PETTE vario 10 – 100 µl**
EUR 244,00
Ident. No. 0020011214
- ⑤ **PETTE vario 20 – 200 µl**
EUR 244,00
Ident. No. 0020011215
- ⑥ **PETTE vario 100 – 1000 µl**
EUR 244,00
Ident. No. 0020011216
- ⑦ **PETTE vario 0.5 – 5 ml**
EUR 244,00
Ident. No. 0020011217
- ⑧ **PETTE vario 1 – 10 ml**
EUR 244,00
Ident. No. 0020011218

	PETTE VARIO	MAX. VOLUME TIP
①	0.1 – 2 µl	10 µl
②	0.5 – 10 µl	10 µl
③	2 – 20 µl	200 µl
④	10 – 100 µl	200 µl
⑤	20 – 200 µl	200 µl
⑥	100 – 1000 µl	1000 µl
⑦	0.5 – 5 ml	5 ml
⑧	1 – 10 ml	10 ml

PETTE MicroKit A

EUR 633,00

Ident. No. 0010007638

PETTE MicroKit B

EUR 633,00

Ident. No. 0010007639

PETTE MacroKit

EUR 647,00

Ident. No. 0010007641

PETTE Classic Kit

EUR 633,00

Ident. No. 0010013011

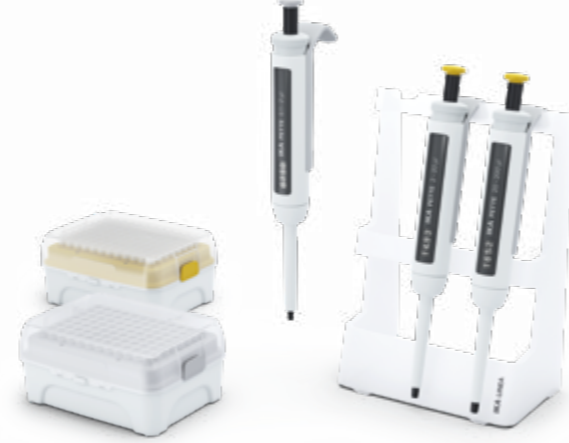

RONDA



Universal fit pipette tips



IKA Tip 1000 µl box

Product	Description	Ident. No.	Price
ACCESSORIES			
LINEA	Pipette rack	0020018987	EUR 72,50
RONDA	Carousel stand for up to 6 pipettes	0020107134	EUR 103,00
Tip 10 µl bag	Pipette tip, 10 µl, transparent, 1000 pcs.	0020114634	EUR 15,30
IKA Tip 10 µl box	Pipette tip, 10 µl, transparent, 960 pcs.	0020116857	EUR 60,50
Tip xs box +	Filter tip, 10 µl, sterile, transparent, 1920 pcs.	0020017820	EUR 202,00
Tip s bag	Pipette tip, 200 µl, transparent, 10 000 pcs.	0020017822	EUR 157,00
Tip 200 µl bag	Pipette tip, 200 µl, transparent, 1000 pcs.	0020114635	EUR 11,60
IKA Tip 200 µl box	Pipette tip, 200 µl, transparent, 960 pcs.	0020116858	EUR 60,50
Tip s tray	Pipette tip, 200 µl, transparent, 1920 pcs.	0020017823	EUR 78,00
Tip s box	Pipette tip, 200 µl, transparent, 1920 pcs.	0020101787	EUR 89,50
Tip s box +	Filter tip, 200 µl, sterile, transparent, 1920 pcs.	0020017824	EUR 202,00
IKA Tip 1000 µl bag	Pipette tip, 1000 µl, transparent, 1000 pcs.	0020114635	EUR 11,60
IKA Tip 1000 µl box	Pipette tip, 1000 µl, transparent, 600 pcs.	0020116859	EUR 47,50
Tip m box +	Filter tip, 1000 µl, sterile, transparent, 1920 pcs.	0020100000	EUR 157,00
Tip l bag	Pipette tip, 5 ml, transparent, 2500 pcs.	0020017829	EUR 214,00
Tip l box	Pipette tip, 5 ml, transparent, 500 pcs.	0020017830	EUR 112,00
Tip xl bag	Pipette tip, 10 ml, transparent, 1000 pcs.	0020017831	EUR 224,00
Tip xl box	Pipette tip, 10 ml, transparent, 250 pcs.	0020017832	EUR 135,00
PETTE.GR.1	Pipette grease, 1 g	0020017692	EUR 2,90
PETTE.GR.45	Pipette grease, 45 g	0020119238	EUR 84,00
Filter L	Filter for single-channel pipette 5 ml, 100 pcs.	0020016449	EUR 39,00
Filter XL	Filter for single-channel pipette 10 ml, 100 pcs.	0020016450	EUR 39,00

PETTE MicroKit A

- PETTE vario 0.1 – 2 µl
- PETTE vario 0.5 – 10 µl
- PETTE vario 10 – 100 µl
- LINEA Pipette rack
- Tip xs box
- Tip xs box

PETTE MicroKit B

- PETTE vario 0.1 – 2 µl
- PETTE vario 2 – 20 µl
- PETTE vario 20 – 200 µl
- LINEA Pipette rack
- Tip xs box
- Tip xs box

PETTE Classic Kit

- PETTE vario 2 – 20 µl
- PETTE vario 20 – 200 µl
- PETTE vario 100 – 1000 µl
- LINEA Pipette rack
- Tip s box
- IKA Tip 1000 µl box

PETTE MacroKit

- PETTE vario 100 – 1000 µl
- PETTE vario 0.5 – 5 ml
- PETTE vario 1 – 10 ml
- LINEA Pipette rack
- Tip m box
- Tip l box
- Tip xl box



SOFTWARE
Pipette Calibration Software

EUR 230,00
Ident. No. 0020022141

User-friendly calibration software for planning, performing and recording all calibration tests.

Free 30 day trial available

We are expanding the portfolio of IKA reactor systems: EasySyn is optimized for organic and aqueous syntheses. As a result, the controllable and reproducible reaction conditions make EasySyn ideal for applications in research and development, the chemical industry or materials research.

EasySyn reactor system

/// The reactor system for chemical synthesis



> Check
Configurator

EVERYTHING FROM ONE HAND

EasySyn is the only reactor system for which you can get all the complementary components from a single source: Overhead stirrers, circulators, vacuum pumps and controllers, sensors and automation software. All from IKA and all perfectly matched to each other.

WIDE RANGE OF APPLICATIONS

The EasySyn reactor systems are characterized by a wide range of applications such as reflux condensations, reactions under vacuum, crystallizations, (pH-controlled) precipitation reactions, nanoparticle or catalyst syntheses as well as the transfer from laboratory to process scale.

ERGONOMIC AND SAFE

They are unique thanks to the ergonomically designed stand. It allows quick and easy exchange of the reactor vessels, simple alignment of the stirrer and adjustment of the working height to the user's body size.



① EasySyn 500 Starter Reactor System

EUR 7.426,00
Ident. No. 0020113433



① EasySyn 2000 Starter Reactor System

EUR 8.369,00
Ident. No. 0020113438



② EasySyn 1000 Starter Reactor System

EUR 7.534,00
Ident. No. 0020113435



② EasySyn 5000 Starter Reactor System

EUR 8.710,00
Ident. No. 0020113442



① EasySyn 500 Advanced Reactor System

EUR 10.144,00
Ident. No. 0020113434



① EasySyn 2000 Advanced Reactor System

EUR 11.087,00
Ident. No. 0020113440



② EasySyn 1000 Advanced Reactor System

EUR 10.252,00
Ident. No. 0020113436



② EasySyn 5000 Advanced Reactor System

EUR 11.428,00
Ident. No. 0020113443



TECHNICAL DATA

	EasySyn Starter	EasySyn Advanced
Useful volume max.	500 ml, 1000 ml, 2000 ml, 5000 ml	
Operating temperature	-50°C – 200°C	
Attainable vacuum	3 mbar	
Openings reactor vessel (number / standard)	1 × centre NS 29/32, 2 × NS 29/32, 1 × NS 14/23	
Stand dimensions (W × H × D)	500 × 950 × 580 mm	
Draining set LT 5.40	–	inclusive
Overhead stirrer	EUROSTAR 60 digital	EUROSTAR 100 control
Torque max. at the stirrer shaft	60 Ncm	100 Ncm
Timer	–	Yes
RS 232 interface	–	Yes
USB interface	–	Yes
Reversible direction of rotation	–	Yes
Torque display	–	Yes

Further package
information on
page 172



SY 500

SY 5000 D



SY 100.1

SY 150.2



R 4012 SY

R 4022 SY

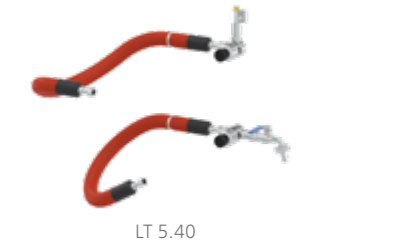

LT 5.40



SY NS.8

LT 5.32

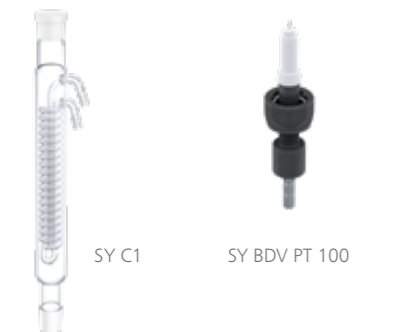

SY C1

SY BDV PT 100

Product	Description	Ident. No.	Price
ACCESSORIES EASYSYN			
SY 500	Reactor vessels 500 ml	0020113459	EUR 1.276,00
SY 500 D	Reactor vessels 500 ml with bottom discharge	0020113460	EUR 2.186,00
SY 1000	Reactor vessels 1000 ml	0020113461	EUR 1.351,00
SY 1000 D	Reactor vessels 1000 ml with bottom discharge	0020113462	EUR 2.321,00
SY 2000	Reactor vessels 2000 ml	0020113463	EUR 1.998,00
SY 2000 D	Reactor vessels 2000 ml with bottom discharge	0020113464	EUR 3.003,00
SY 5000	Reactor vessels 5000 ml	0020113465	EUR 2.296,00
SY 5000 D	Reactor vessels 5000 ml with bottom discharge	0020113466	EUR 3.398,00
SY 100.1	Reactor lid DN 100	0020113649	EUR 472,00
SY 100.2	Reactor lid DN 100	0020116965	EUR 787,00
SY 150.1	Reactor lids DN 150	0020113660	EUR 668,00
SY 150.2	Reactor lids DN 150	0020113661	EUR 839,00
R 4011 SY	Propeller stirrer, PTFE, 400 mm	0020114111	EUR 263,00
R 4012 SY	Propeller stirrer, PTFE, 480 mm	0020114112	EUR 284,00
R 4013 SY	Propeller stirrer, PTFE, 530 mm	0020114113	EUR 315,00
R 4021 SY	Anchor stirrer, PTFE, 410 mm	0020114114	EUR 315,00
R 4022 SY	Anchor stirrer, PTFE, 530 mm	0020114115	EUR 347,00
LT 5.40	Draining set for Reactor system	0020113266	EUR 1.911,00
SY stand	Stand system	0020103316	EUR 3.297,00
SY clamp 100	Vessel clamp DN 100	0020105944	EUR 683,00
SY clamp ring 100	Clamp ring DN 100	0020113866	EUR 161,00
SY O-ring 100	O-Ring DN 100	0020113867	EUR 51,50
SY guide	Stirrer guide	0020109139	EUR 315,00
SY clamp 150	Clamp ring DN 150	0020105879	EUR 788,00
SY clamp ring 150	Clamp ring DN 150	0020113868	EUR 188,00
SY O-ring 150	O-Ring DN 150	0020113869	EUR 64,50
SY NS.6	Swivelling screw fitting 6 mm	0020113165	EUR 154,00
SY NS.8	Swivelling screw fitting 8 mm	0020113164	EUR 147,00
SY NS.12	Swivelling screw fitting 12 mm	0020113163	EUR 147,00
LT 5.30	Tempering hose 800 mm	0020108012	EUR 680,00
LT 5.31	Tempering hose 1200 mm	0020110278	EUR 756,00
LT 5.32	Tempering hose 1600 mm	0020113271	EUR 831,00
PT 100.300	Temperature sensor 300 mm	0020114304	EUR 378,00
PT 100.500	Temperature sensor 500 mm	0020114305	EUR 410,00
SY pH 325	pH-Electrode 325 mm	0020114414	EUR 839,00
SY pH 425	pH-Electrode 425 mm	0020114415	EUR 892,00
SY C1	Reflux condenser	0020113927	EUR 155,00
SY VC	Vacuum cock NS 14/23	0001970900	EUR 131,00
SY BDV PT 100	Bottom discharge valve with integrated temperature sensor	0020121894	EUR 932,00
H 71.32*	Temperature sensor 320 mm	0020117772	EUR 481,00
H 71.45*	Temperature sensor 450 mm	0020118833	EUR 521,00
R 270.extension	Extension for R 270	0020007927	EUR 69,00

* For connection to a EUROSTAR control overhead stirrer

LR 1000 basic System

EUR 7.572,00
Ident. No. 0020119960

- LR 1000 basic base
- LR 1000.1 Laboratory reactor vessel
- LR 1000.61 Sensor receptacle
- PT 100.30 Temperature sensor
- Support rod
- Hose connectors for cooling hoses (2 pcs.)



With just one base unit multiple vessels can be used!

LR 1000 control System

EUR 13.705,00
Ident. No. 0025001991

Weighing range: max. 2 kg



TECHNICAL DATA	LR 1000 BASIC SYSTEM	LR 1000 CONTROL SYSTEM
Usable volume (with disperser tool)	500 – 1000 ml	500 – 1000 ml
Attainable vacuum	25 mbar	25 mbar
Max. viscosity	100 000 mPas	100 000 mPas
Speed range	10 – 150 rpm	10 – 150 rpm
Display	LED	TFT
Working temperature max.	120 °C	120 °C
Vessel specification	FKM sealing; anchor stirrer	FFKM sealing; anchor stirrer with scraper
pH measurement	–	Yes (BNC)
Cooling water control	–	Yes
Heat control accuracy of medium with sensor	± 0.2 K	± 0.2 K
Heat output	1000 W	1000 W
Dimensions (W x H x D)	443 x 360 x 295 mm	443 x 360 x 295 mm

- LR 1000 control base
- LR 1000.3 Laboratory reactor vessel
- LR 1000.10 Anchor stirrer with PEEK scrapers
- LR 1000.62
- PT 100.30 Temperature sensor
- Silentstream
- Support rod
- Hose connectors (2 pcs.)
- USB Cable 2 m

LR-2.ST The High-Performer

EUR 15.213,00
Ident. No. 0020013291

EUROSTAR 200 control P4
Overhead stirrer
LR2.10 Reactor cover
LR-2.SI Safety disconnection
LR-2.ST Stand system



LR-2.ST The Allrounder

EUR 13.864,00
Ident. No. 0020013292

EUROSTAR 200 control
Overhead stirrer
LR2.10 Reactor cover
LR-2.SI Safety disconnection
LR-2.ST Stand system



LR-2.ST The Versatile

EUR 13.291,00
Ident. No. 0020013293

EUROSTAR 100 control
Overhead stirrer
LR2.10 Reactor cover
LR-2.SI Safety disconnection
LR-2.ST Stand system



LR-2.ST The Compact Power

EUR 12.599,00
Ident. No. 0020013294

EUROSTAR 60 control
Overhead stirrer
LR2.10 Reactor cover
LR-2.SI Safety disconnection
LR-2.ST Stand system



Discover the variety of equipment options with accessories on page 148 and at www.ika.com



TECHNICAL DATA	LR-2.ST
Min. volume (anchor stirrer)	500 ml
Min. volume (T 25 digital)	800 ml
Max. volume	2000 ml
Max. working temperature	230 °C
Attainable vacuum	25 mbar
Max. viscosity (EUROSTAR 200 control P4)	150 000 mPas
Speed range (EUROSTAR 200 control P4)	0/4 – 530 rpm
Max. torque at stirring shaft (EUROSTAR 200 control P4)	660 Ncm
Materials in contact with medium	Stainless steel (AISI 316L) FFPM Borosilicate glass 3.3 PTFE
Height of telescopic stand	620 – 1010 mm
Dimensions (W x H x D)	460 x 1240 x 430 mm

LR-2.ST STARVISC 200 /// Stirs and displays viscosity

The reactor system is particularly helpful for product development, due to the used overhead stirrer, STARVISC 200-2.5 control, which is able to measure viscosity while stirring. This feature enables unique process monitoring and control during synthesis or mixing. Using the agitator mounting, a safe transfer of the high motor torque is feasible, which enables stirring of even highly viscous substances.

In addition, ULTRA-TURRAX® dispersers, temperature sensors, flow breakers and other accessories can be attached to the open ports of the reactor cover.

TECHNICAL DATA	LR-2.ST STARVISC 200
Min. volume (anchor stirrer)	500 ml
Max. volume	2000 ml
Max. working temperature	230 °C
Attainable vacuum	25 mbar
Max. viscosity	100 000 mPas
Speed min.	6 rpm
Max. torque at stirring shaft	200 Ncm
Materials in contact with medium	Stainless steel (AISI 316L) FFPM Borosilicate glass 3.3 PTFE
Telescope stand stroke	620 – 1010 mm
Dimensions (W x H x D)	460 x 1240 x 430 mm



LR-2.ST STARVISC 200
EUR 16.643,00
Ident. No. 0020020603

LR-2.ST STARVISC 200
Package
STARVISC 200-2.5 control
Measuring stirrer
LR2.10 Reactor cover
LR-2.SI Safety disconnection
LR-2.ST Stand system



WiCo LR 1000

LR 1000.3



LR 1000.10



LR 1000.20



LR 1000.41



LR 1000.64



LR 1000.70



MV 1

Product	Description	Ident. No.	Price
ACCESSORIES LR 1000			
WiCo LR 1000	Wireless controller	0020007267	EUR 664,00
LR 1000.1	Reactor vessel, 1000 ml, FKM sealings, 4 connectors, anchor stirrer	0003602000	EUR 3.881,00
LR 1000.3	Reactor vessel, 1000 ml, FFKM sealings, 6 connectors, anchor stirrer with PEEK scrapers	0025001955	EUR 4.832,00
LR 1000.10	Anchor stirrer with PEEK scrapers	0004663100	EUR 488,00
LR 1000.11	Anchor stirrer, stainless steel	0004663000	EUR 287,00
LR 1000.20	Flow breaker / baffle, stainless steel	0004663200	EUR 381,00
LR 1000.40	Shaft receptacle FFKM	0025001950	EUR 616,00
LR 1000.41	Shaft receptacle for dispersing tool	0004664300	EUR 535,00
LR 1000.61	Temperature sensor receptacle	0004664400	EUR 490,00
LR 1000.62	Sensor receptacle GL 14	0020010508	EUR 419,00
LR 1000.64	pH electrode	0004663300	EUR 976,00
LR 1000.65	pH electrode receptacle	0004663400	EUR 827,00
LR 1000.70	Lid holder	0025003123	EUR 277,00
MV 1	Magnetic valve for cooling water control, max. 100 °C	0020003763	EUR 495,00
Holder MV 1	Holder for cooling water control valve	0020019816	EUR 222,00

ACCESSORIES LR-2.ST

LR-2.SI	Safety stop	0003318300	EUR 1.085,00
LR 2000.10	Anchor stirrer with PEEK scraper	0002508400	EUR 1.630,00
LR 2000.11	Anchor stirrer, stainless steel	0002509500	EUR 761,00
LR 2000.20	Flow breaker / baffle, stn. steel	0002508500	EUR 747,00
LR 2.1	Glass reactor vessel, single-walled, 2000 ml	0003070000	EUR 938,00
LR 2000.1	Glass reactor vessel, double-walled, 2000 ml	0002508300	EUR 4.216,00
LR 2000.2	Glass reactor vessel, double-walled, bot. drain 2000 ml	0002509600	EUR 5.295,00
LR 2000.3	Stainless steel reactor vessel, double-walled, 2000 ml	0002509700	EUR 6.069,00
LR 2000.4	Stainless steel reactor vessel, double-walled, bot. drain, 2000 ml	0003064900	EUR 10.074,00



LR 2000.10



LR 2000.11



LR 2.1



LR 2000.1



LR 2000.2



LR 2000.3



LR 2000.4



HBR 4 control LR



LT 5.28

Product	Description	Ident. No.	Price
ACCESSORIES LR-2.ST			
LR 2000.40	Shaft receptacle	0002509200	EUR 663,00
LR 2000.60	Sensor receptacle	0002509300	EUR 598,00
LR 2000.64	pH process electrode	0020010075	EUR 1.385,00
LR 2000.65	pH measuring sensor receptacle	0003172600	EUR 978,00
LR-2.SP	Splinter shield	0003326400	EUR 500,00
LT 5.23 M 16	Adapter G1/4 m - M16x1 m	0020106236	EUR 155,00
LT 5.25	Lock coupling NPT	0020000878	EUR 602,00
LT 5.26	Lock adapter set	0020000879	EUR 412,00
LT 5.25 200C	Lock coupling 200 °C	0020120795	EUR 488,00
LT 5.26 200C	Lock adapter 200 °C	0020120796	EUR 367,00
LT 5.27	Hose adapter set	0020000880	EUR 602,00
LT 5.28	Pressure control valve	0020100227	EUR 213,00
H 68.55	Temp. sensor, stn. steel, Ø 6 mm	0025007921	EUR 320,00
HBR 4 control LR	Heating bath, 4 l	0010001849	EUR 4.811,00
PT 1000.61	Temperature sensor, stn. steel, Ø 6 mm	0020009881	EUR 303,00

ACCESSORIES REACTOR SYSTEM

T 25 digital LR	Disperser	0020008820	EUR 2.541,00
S 25 KV - 25 G	Dispersing element, Ø 25 mm	0002466900	EUR 2.423,00
S 25 KV - 25 F	Dispersing element, Ø 25 mm	0002404000	EUR 2.544,00
S 25 KV - 26 LR	Dissolver stirrer, high speed	0020015397	EUR 2.270,00
S 25 KD - LR - 25 G	Dispersing element, length: 267 mm	0025007321	EUR 2.270,00
S 25 KD - LR - 25 F	Dispersing element, length: 267 mm	0025007322	EUR 2.333,00



T 25 digital LR



S 25 KD - LR - 25 G



S 25 KD - LR - 25 F

Advanced software with an innovative visual approach to lab automation. labworldsoft® is a multi-purpose software program for measuring, controlling and regulating laboratory devices. It can network up to 64 devices simultaneously via one PC, thus making the automation of your laboratory experiments and processes much more easy and efficient. It does not only integrate IKA laboratory devices but also supports devices from other manufacturers.

LABWORLDISOFT® 6

/// One software, unlimited possibilities



labworldsoft® 6 Starter

EUR 5.056,00
Ident. No. 0020019397

labworldsoft® 6 Starter Update

EUR 1.013,00
Ident. No. 0020019398

labworldsoft® 6 Advanced

EUR 8.809,00
Ident. No. 0020105873

labworldsoft® 6 Advanced Update

EUR 1.762,00
Ident. No. 0020105874

labworldsoft® 6 Starter Upgrade

EUR 6.482,00
Ident. No. 0020019399

labworldsoft® 6 Pro

EUR 11.537,00
Ident. No. 0020017366

labworldsoft® 6 Pro Update

EUR 2.308,00
Ident. No. 0020018014



C 6040 CalWin

EUR 2.524,00
Ident. No. 0004040500

CalWin represents the newest generation of professional software for IKA calorimeters. It offers numerous functions for device control and monitoring as well as for evaluating results.



Expert Key 100 eco

Expert Key 100 pro



ETH SER 4



PCI 8.2

Product	Description	Ident. No.	Price
Expert Key 100 eco	Data collection system for laboratories	0020005486	EUR 6.299,00
Expert Key 100 pro	Data collection system for industries	0020005485	EUR 6.799,00
Multi power switch	Switchable multiple connection plug board	0020003454	EUR 102,00
MV 1 power plug	Cooling water valve with power plug	0010001655	EUR 606,00
RV 10 A 1	Adapter valve for Expert Key	0020004314	EUR 139,00
PT 100.1 A 1	Adapter LEMO for Expert Key	0020004315	EUR 93,50
PT 1000 A 1	Adapter DIN 6 for Expert Key	0020004316	EUR 96,00
PT 100.10 A 1	Adapter DIN 5 for Expert Key	0020004317	EUR 38,00
PC 1.1	Cable, L 3 m	0002616700	EUR 45,50
PC 1.3	Cable, L 1.5 m	0025005322	EUR 37,00
PC 1.5	Cable, L 2.5 m	0002756000	EUR 50,50
PC 2.1	Cable, L 5 m	0002700700	EUR 19,10
PC 3.1	Cable, L 3 m, 9 pins (F), 15 pins (M)	0020122152	EUR 59,00
USB 3.0 EXT 10	USB 3.0 extension cable, L 10 m	0020021255	EUR 161,00
USB A-B cable	USB A-B cable	0004220200	EUR 6,30
DTM 12.10	Data cable, L 2.5 m, 9 pins (F)	0003127800	EUR 404,00
PC 1.2	Adapter, 25 pins	0002616800	EUR 72,50
PC 1.4	Adapter, 9 pins (F), 15 pins (M)	0002755900	EUR 94,50
PC 2.2	Adapter, 9 pins (F), 25 pins (M)	0002753200	EUR 72,50
PCI 8.2	Plug-in card, 25 pins	0008017500	EUR 1.513,00
USB SER 4	USB-serial converter 4 ports	0020003456	EUR 428,00
USB SER 8	USB-serial converter 8 ports	0020018480	EUR 734,00
USB SER 16	USB-serial converter 16 ports	0020018736	EUR 1.270,00
USB Hub 2.0 4	USB hub 2.0 4 ports	0020021256	EUR 108,00
USB Hub 2.0 7	USB hub 2.0 7 ports	0020021257	EUR 202,00
USB ISO	USB isolator	0020101935	EUR 186,00
ETH SER 4	Ethernet-serial converter 4 ports	0003192000	EUR 1.670,00
ETH SER 8	Ethernet-serial converter 8 ports	0020021350	EUR 2.120,00
ETH SER 16	Ethernet-serial converter 16 ports	0020021351	EUR 2.538,00

IKA oxygen bomb calorimeters are the market leaders when it comes to determining the calorific values of liquid and solid samples. The selection of IKA oxygen bomb calorimeters are optimally geared towards various different demands. Functionality, safety and longevity were the main goals in the development of IKA's oxygen bomb calorimeters.

C 6000

/// An evolution in calorimetry

The champion of modern calorimetry has been developed even further. The C 6000 has an intuitive touch screen with unique user guidance. The high level of automation simplifies everyday work and enables high sample throughput. The strictest adherence to standards gives rise to the most accurate repeatable results in the world and guarantees the desired assurance.



C 1 Package 1/10

Price on request
Ident. No. 0010005633

C 1 Package 2/10

Price on request
Ident. No. 0010005634

C 1 Package 3/10

Price on request
Ident. No. 0010005635

C 1 Package 1/12

Price on request
Ident. No. 0010005636

C 1 Package 2/12

Price on request
Ident. No. 0010005637

C 1 Package 3/12

Price on request
Ident. No. 0010005638



C 200

Price on request
Ident. No. 0008802500

C 200 h

Price on request
Ident. No. 0008803700

C 200 auto

Price on request
Ident. No. 0010002379

C 200 h auto

Price on request
Ident. No. 0010002387

TECHNICAL DATA	C 1	C 200 C 200 H
Maximum energy input	40 000 J / 9560 cal	40 000 J / 9560 cal
Resolution of the temperature sensor	0.0001 K	0.0001 K
Power ON-time	100 %	100 %
Oxygen operating pressure max.	40 bar	40 bar
Measuring modes / Measurements per hour	Static jacket (Regnault Pfaundler) 4	Isoperibol 3, Dynamic 6 Manual 3, Time-controlled 4
Start temperature settings	2 possible settings: 22 °C or 30 °C	18 – 25 °C
Reproducibility (1g benzoic acid NBS39i)	Static jacket (Regnault Pfaundler) 0.15 % RSD	Isoperibol 0.1 % RSD Dynamic 0.1 % RSD Manual (Isoperibol) 0.1 % RSD Time-controlled 0.1 % RSD
Number of decomposition vessels per unit	up to 2	up to 4
Dimensions (W × H × D)	290 × 280 × 300 mm	400 × 400 × 400 mm

Further package information on page 166

**C 6000 isoperibol
Package 1/10**Price on request
Ident. No. 0010004524**C 6000 isoperibol
Package 1/12**Price on request
Ident. No. 0010004525**C 6000 isoperibol
Package 2/10**Price on request
Ident. No. 0010004526**C 6000 isoperibol
Package 2/12**Price on request
Ident. No. 0010004527**C 6000 global standards
Package 1/10**Price on request
Ident. No. 0010004520**C 6000 global standards
Package 1/12**Price on request
Ident. No. 0010004521**C 6000 global standards
Package 2/10**Price on request
Ident. No. 0010004522**C 6000 global standards
Package 2/12**Price on request
Ident. No. 0010004523

TECHNICAL DATA

Maximum energy input	40 000 J / 9560 cal
Resolution of the temperature sensor	0.0001 K
Display	TFT with touch screen
Oxygen operating pressure max.	40 bar
Reproducibility (1g benzoic acid NBS39i)	Isoperibol 0.05% RSD Dynamic 0.15% RSD Adiabatic 0.05% RSD
Measuring modes	Isoperibol 22 / 25 / 30 °C Dynamic 22 / 25 / 30 °C Adiabatic 22 / 25 / 30 °C
Measurements per hour	Isoperibol 4 Dynamic 6 Adiabatic 5
Number of possible decomposition vessels per device	up to 4
Dimensions (W x H x D)	500 x 425 x 450 mm

C 6000 ISOPERIBOL I
GLOBAL STANDARDS**AOD 1**Price on request
Ident. No. 0008801300**C 7000 Set 1**Price on request
Ident. No. 0008800900**C 7000 Set 2**Price on request
Ident. No. 0008801400Further package
information on
page 165

TECHNICAL DATA

TECHNICAL DATA	C 7000
Maximum energy input	30 000 J
Resolution of the temperature sensor	0.0001 K
Display	LED
Oxygen operating pressure max.	40 bar
Reproducibility (1g benzoic acid NBS39i)	0.2 % RSD
Measuring modes	Double dry (ISO 1928)
Working temperature max.	30 °C
Number of possible decomposition vessels per device	8
Dimensions (W x H x D)	310 x 395 x 490 mm

TECHNICAL DATA

TECHNICAL DATA	AOD
Decomposition time	3 min
Chamber volume	210 ml
Pressure max.	195 bar
Core temperature max.	1200 °C
Oxygen operating pressure max.	40 bar
Permissible ambient temperature	min. 5 °C max. 40 °C
Weight	12.5 kg
Dimensions (W x H x D)	400 x 480 x 260 mm
Power input	45 W



C 1.12



C 1.20



C 1.50



C 6010



C 6030



C 21

Product	Description	Ident. No.	Price
ACCESSORIES AND CONSUMABLES C 1			
C 1/10	Food add on Package for C 1	0010001917	EUR 5.322,00
C 1.20	Water heater	0004501000	EUR 1.386,00
C 1.10	Combustion chamber	0004500300	EUR 989,00
C 1.12	Combustion chamber, halogen resistant	0004500400	EUR 2.877,00
C 1.50	Dot matrix printer	0004500600	EUR 950,00
C 1.30	Venting station	0004500900	EUR 2.125,00
C 1.1012	Organizer	0004500700	EUR 188,00
C 1.101	Set of spare parts, approx. 1000 experiments	0004502200	EUR 358,00
C 1.121	Set of spare parts, approx. 1000 experiments	0004502300	EUR 733,00
C 1.103	Ignition wire, Kanthal, 5 pcs.	0004579300	EUR 46,00
C 1.123	Ignition wire, platinum, 2 pcs.	0004500200	EUR 153,00
ACCESSORIES AND CONSUMABLES C 6000			
C 6010	Decomposition vessel, standard	0003770000	EUR 3.296,00
C 6012	Decomposition vessel, halogen resistant	0004504000	EUR 6.221,00
C 6010 HE	Standard decomposition vessel with hastelloy electrodes	0020007660	EUR 3.944,00
C 6010.10	Combustion shield	0020007518	EUR 119,00
C 1.50	Dot matrix printer	0004500600	EUR 950,00
C 6030	Venting station	0004504100	EUR 2.504,00
C 60.1012	Organizer	0004504200	EUR 263,00
C 6000.10	Set of spare parts, approx. 1000 experiments	0004504300	EUR 1.031,00
C 6000.12	Set of spare parts, approx. 1000 experiments	0004504400	EUR 2.624,00
C 1.103	Ignition wire, standard, Kanthal, 5 pcs.	0004579300	EUR 46,00
C 1.123	Ignition wire, platinum, 2 pcs.	0004500200	EUR 153,00
ACCESSORIES ALL CALORIMETERS			
C 27	Calorimeter preparation set	0004579700	EUR 125,00
C 29 (DIN 477)	Pressure regulator, oxygen	0000750200	EUR 1.222,00
C 29 (BS341-3)	Pressure regulator, oxygen	0020101322	EUR 1.222,00
C 29 (NFE29-656)	Pressure regulator, oxygen	0020101828	EUR 1.222,00
C 21	Pelleting press	0001605300	EUR 3.504,00
C 5010.8	Crucible holder, small	0004579800	EUR 173,00
C 5010.5	Crucible holder, big	0003055900	EUR 210,00



C 200.RC



C 248



C 5010



C 5020



C 48



C 7010.8

Product	Description	Ident. No.	Price
ACCESSORIES C 200			
C 200.RC	Set of hoses	0020010835	EUR 599,00
C 248	Oxygen station	0003520000	EUR 1.085,00
C 200.1	Measuring cup, 2000 ml	0003548900	EUR 48,00
C 200.2	Conversion kit for C 5012	0004028800	EUR 175,00
ACCESSORIES C 200, C 2000, C 5000			
C 5010	Decomposition vessel, standard	0007114000	EUR 4.103,00
C 5012	Decomposition vessel, halogen resistant	0007215000	EUR 8.333,00
C 5010 HE	Standard decomposition vessel with hastelloy electrodes	0003955000	EUR 4.688,00
C 5030	Venting station	0007198000	EUR 3.017,00
C 5010.4	Attachment for combustible crucible C 14	0003016900	EUR 286,00
C 26	Prep stand	0008804000	EUR 234,00
ACCESSORIES C 2000, C 5000, C 6000			
C 5020	Sample rack	0007145000	EUR 6.634,00
ACCESSORIES C 2000, C 5000, C 7000			
C 5041.10	Connection cable	0003036000	EUR 53,00
ACCESSORIES C 1, C 2000, C 6000			
C 25	Pressure regulating valve	0003197200	EUR 397,00
ACCESSORIES C 7000			
C 7000	Measurement cell	0003008000	EUR 31.779,00
C 7010	Decomposition vessel, standard	0003015000	EUR 4.752,00
C 7012	Decomposition vessel, halogen resistant	0003017000	EUR 9.252,00
C 7002	Cooling system	0007011000	EUR 12.157,00
C 48	Oxygen station	0001560000	EUR 2.899,00
C 7030	Venting station	0003013300	EUR 2.257,00
C 7010.8	Venting handle	0007095000	EUR 509,00
C 5010.4	Attachment for combustible crucible C 14	0003016900	EUR 286,00
C 5010.5	Crucible holder, big	0003055900	EUR 210,00



C 5010.4



C 5010.5



Product	Description	Ident. No.	Price
CONSUMABLES ALL CALORIMETERS			
C 6000.1*	Water protect, 100 ml	0020014031	EUR 89,00
C 710.4	Cotton thread, cut to length, 500 pcs.	0001483700	EUR 41,00
C 710.8	Cotton thread, cut to length, thick, 500 pcs.	0004579900	EUR 41,50
C 4	Quartz dish	0001695500	EUR 32,00
C 5	Set of VA combustion crucibles, 25 pcs.	0001749500	EUR 153,00
C 6	Quartz dish, big	0000355100	EUR 44,50
C 710.2	Set of VA combustion crucibles, big, 25 pcs.	0001483500	EUR 237,00
C 9	Gelatine capsules, 100 pcs.	0000749900	EUR 42,50
C 10	Acetobutyrate capsules, 100 pcs.	0000750000	EUR 112,00
C 12	Combustion bags, 40 × 35 mm, 100 pcs.	0002201400	EUR 44,50
C 12 A	Combustion bags, 70 × 40 mm, 100 pcs.	0002201500	EUR 45,50
C 15	Parafilm strips	0003131100	EUR 55,00
C 16	Parafilm, 1000 × 50 mm	0003801100	EUR 63,00
C 17	Paraffin, liquid, 30 ml	0003801200	EUR 103,00
C 43	Benzoic acid, NIST 39j, 30 g	0000750600	EUR 681,00
C 723	Benzoic acid, blister package, 50 pcs.	0003243000	EUR 149,00
C 723 Big Pack	Benzoic acid, blister package, 450 pcs.	0003717400	EUR 935,00
AOD 1.11	Control standard oil for S, Cl, 50 ml	0003044000	EUR 327,00
CONSUMABLES C 200, C 2000, C 5000, C 7000			
C 5010.3	Ignition wire, spare, 5 pcs.	0007122800	EUR 60,00
C 5012.3	Ignition wire, spare, 5 pcs.	0002994900	EUR 166,00
C 14	Combustible crucibles, 100 pcs.	0007224500	EUR 111,00

* Use biocidal product carefully.
Always read the label and product information before use.
Active ingredients: < 0.1 % Bardap 26, < 0.1 % Diamine



Product	Description	Ident. No.	Price
ACCESSORIES AOD 1			
AOD 1.1 FZ	Decomposition vessel	0003303000	EUR 6.631,00
AOD 1.2	External ignition unit	0003348000	EUR 1.557,00
AOD 1.3	Protection device	0003308000	EUR 2.615,00
AOD 1.13	Remote ignition head	0003348100	EUR 734,00
C 48	Oxygen station	0001560000	EUR 2.899,00
C 7030	Venting station	0003013300	EUR 2.257,00
C 21	Pelleting press	0001605300	EUR 3.504,00
C 29 (DIN 477)	Pressure gauge, oxygen	0000750200	EUR 1.222,00
C 29 (BS341-3)	Pressure gauge, oxygen	0020101322	EUR 1.222,00
C 29 (NFE29-656)	Pressure gauge, oxygen	0020101828	EUR 1.222,00
C 5010.4	Attachment for combustible crucible C 14	0003016900	EUR 286,00
CONSUMABLES AOD 1			
C 4	Quartz dish	0001695500	EUR 32,00
C 9	Gelatine capsules, 100 pcs.	0000749900	EUR 42,50
C 10	Acetobutyrate capsules, 100 pcs.	0000750000	EUR 112,00
C 12	Combustion bags, 40 × 35 mm, 100 pcs.	0002201400	EUR 44,50
C 12 A	Combustion bags, 70 × 40 mm, 100 pcs.	0002201500	EUR 45,50
C 14	Combustible crucibles, 100 pcs.	0007224500	EUR 111,00
C 15	Parafilm strips	0003131100	EUR 55,00
C 5012.3	Ignition wire, platinum, 2 pcs.	0002994900	EUR 166,00
C 710.4	Cotton thread, cut to length, 500 pcs.	0001483700	EUR 41,00
AOD 1.11	Control standard oil for S, Cl, 50 ml	0003044000	EUR 327,00
C 723	Benzoic acid, blister package, 50 pcs.	0003243000	EUR 149,00
C 723 Big Pack	Benzoic acid, blister package, 450 pcs.	0003717400	EUR 935,00

C 6040 CalWin

EUR 2.524,00
Ident. No. 0004040500*

* Connection cable C 5041.10 and USB / RS 232 adapter are included with the delivery



R 200

R 270



RH 5

LABLIFT m

Product	Description	Ident. No.	Price
FIXING ELEMENTS			
H 44	Boss head clamp	0002437700	EUR 39,00
R 200	Clamp for T 10 basic and R 104	0003372000	EUR 42,00
R 182	Boss head clamp, clamping range Ø 6 – 16 mm	0002657700	EUR 104,00
R 270	Boss head clamp, clamping range Ø 25 – 36 mm	0002657800	EUR 137,00
R 271	Boss head clamp, clamping range Ø 34 mm	0002664000	EUR 221,00
R 350	Universal clamp	0001752900	EUR 131,00
RH 3	Strap clamp for stand Ø 8 – 16 mm	0003008600	EUR 338,00
RH 5	Strap clamp for stand Ø 25 – 36 mm	0003159000	EUR 416,00
LABLIFT m	Manual scissor lift	0004022400	EUR 351,00

STANDS

R 104	Stand for T 10 basic, H 370 mm	0003386000	EUR 193,00
R 1825	Plate stand, H 560 mm	0003160000	EUR 331,00
R 1826	Plate stand, H 800 mm	0003160100	EUR 365,00
R 1827	Plate stand, H 1000 mm	0003160200	EUR 389,00
R 2722	H-stand, 1010 mm	0001412000	EUR 794,00
R 2723	Telescopic stand, H 620-1010 mm	0001412100	EUR 1.473,00
T 653	Telescopic stand, H 1200 mm	0001608000	EUR 2.074,00
R 474	Telescopic stand, H 1200 mm	0001643000	EUR 2.074,00
R 472	Floor stand, H 2020 mm	0000738700	EUR 4.407,00
R 2850	Floor stand, H 1900 mm	0020002900	EUR 3.241,00
R 6547 H	Floor stand, hydraulic	0020018533	EUR 10.479,00
R 6547.1	Container clamping device for R 6547 H / E floor stand	0020018680	EUR 4.018,00



R 6547 H



R 104

R 1825

R 2722

R 2723

R 474

R 2850



ALMEMO 2490



PT 100.23

Product	Description	Ident. No.	Price
ELECTRONIC STANDS			
IKA [scale]	Stand with weighing function	0025004318	EUR 934,00
R 6547 E 400V	Floor stand, electrohydraulics	0020018673	EUR 15.683,00
R 2850.SI	Safety stop	0020010623	EUR 1.467,00
ALMEMO TEMPERATURE MEASURING INSTRUMENT			
ALMEMO 2490-2	Temperature measuring instrument	0004709300	EUR 2.077,00
ALMEMO USB cable	USB cable	0004709400	EUR 424,00
PT 100.23	Temp. sensor, stn. steel, Ø3 mm, length: 250 mm	0003122100	EUR 342,00
PT 100.24	Temp. sensor, stn. steel, coated, Ø6 mm, 250 mm	0003122200	EUR 351,00
PT 100.25	Temp. sensor, stn. steel, Ø6 mm, 265 mm	0003122300	EUR 282,00

IKA [SCALE]

/// The first stand scale of its kind

A stand with an integrated scale and data interface: only available from IKA. The IKA [scale] provides increased comfort and safety for your laboratory applications. For example, your stirrer can hang on the stable support rod. The quantities of samples to be added are weighed immediately and continuously documented during the stirring process.

SAMPLE WEIGHT OF UP TO 6 KG

The intelligent stand scale has a weighing range of up to 6 kg with a resolution of 1 g. It is therefore particularly suitable for the direct and controlled addition of sample material while stirring.

CLEAR DISPLAY

Working with the clear and modern LCD display is very user-friendly. All information, whether measurement values, calibration steps or status messages, is shown clearly.

STABLE SET-UP PLATE

The solid die cast zinc housing provides stability and robustness.

BLUETOOTH CONNECTION

The weight of the sample measured can directly be transferred to a suitable device (e.g. IKA MINI-/ MICROSTAR series) and shown on its display.

Patented:
The IKA [scale] is
unique in the market!



Do you think in terms of applications instead of individual parts? And you don't want to look for each sensor and each clamp individually? That's exactly what our packages are for. They contain everything you need for a specific application. If yours is not included, our Customer Center will put together your individual complete solution.

COMPLETE SOLUTIONS FROM A SINGLE SOURCE

/// Our Packages

Our packages are assembled ready for connection for a wide range of applications. There are basic packages for simple applications, packages for special applications, safety packages or complete system solutions. So you can be sure that all components harmonize perfectly.

Packages save you time-consuming research, lengthy comparisons and are also attractively priced. Plus, you can rely on our excellent service for all components of your particular system.



RCT basic ready-to-go Solution



RCT basic Synthesis Solution 1000

Product	Description	Ident. No.	Price
MAGNETIC STIRRER PACKAGE			
RCT basic ready-to-go Solution		0010011525	EUR 1.002,00
RCT basic	RCT basic magnetic stirrer, incl. PT 1000.60 temperature sensor	0025005927	
BC 1000	Beaker cap	0020003417	
H 38	Holding rod	0003547700	
H 44	Boss head clamp	0002437700	
H 16 V	Support rod	0001545100	
RCT basic ETS-D5 Solution		0010011496	EUR 1.312,00
RCT basic	RCT basic magnetic stirrer, incl. PT 1000.60 temperature sensor	0025005927	
ETS-D5	Electronic contact thermometer	0003516800	
H 38	Holding rod	0003547700	
H 44	Boss head clamp	0002437700	
H 16 V	Support rod	0001545100	
RCT basic Synthesis Solution 250		0010011505	EUR 1.259,00
RCT basic	RCT basic magnetic stirrer, incl. PT 1000.60 temperature sensor	0025005927	
H 135.25	Flask carrier 250 ml without handle	0025003280	
H 38	Holding rod	0003547700	
H 44	Boss head clamp	0002437700	
H 16 V	Support rod	0001545100	
R 350	Universal clamp	0001545100	
IKAFLO 25 ellipse	Stir bar	0004494800	
RCT basic Synthesis Solution 500		0010011502	EUR 1.259,00
RCT basic	RCT basic magnetic stirrer, incl. PT 1000.60 temperature sensor	0025005927	
H 135.30	Flask carrier 500 ml	0025000639	
H 38	Holding rod	0003547700	
H 44	Boss head clamp	0002437700	
H 16 V	Support rod	0001545100	
R 350	Universal clamp	0001545100	
IKAFLO 30 ellipse	Stir bar	0004495000	
RCT basic Synthesis Solution 1000		0010011508	EUR 1.312,00
RCT basic	RCT basic magnetic stirrer, incl. PT 1000.60 temperature sensor	0025005927	
H 135.40	Flask carrier 500 ml	0025000833	
H 38	Holding rod	0003547700	
H 44	Boss head clamp	0002437700	
H 16 V	Support rod	0001545100	
R 350	Universal clamp	0001545100	
IKAFLO 40 ellipse	Stir bar	0004495400	



UTTD basic IVD Solution



UTTD control Pharma Solution



UTTD control Life Science Solution

Product	Description	Ident. No.	Price
SINGLE-USE CRUSHING / IVD PACKAGES			
ULTRA-TURRAX® P control Workstation		0025005836	EUR 1.699,00
ULTRA-TURRAX® Tube Drive P control	Disperser	0025005981	
ST-20	Stirring tube, 20 ml (3 pcs.)	0003703000	
DT-20	Dispersing tube, 20 ml	0003703100	
Glass balls	(6.0 mm) for BMT tubes	0003599200	
Stainless steel	(5.0 mm) balls for BMT tubes	0003599300	
UTTD basic IVD Solution		0010013007	EUR 998,00
ULTRA-TURRAX® Tube Drive	Disperser	0003646000	
BMT-20-S-IVD.50	Tube with stirring element, sterile, IVD label, 50 pcs., membrane lid	0020027186	
UTTD control IVD Solution		0010013008	EUR 1.799,00
ULTRA-TURRAX® Tube Drive P control	Disperser	0025005981	
BMT-20-S-IVD.50	Tube with stirring element, sterile, IVD label, 50 pcs., membrane lid	0020027186	
UTTD control Pharma Solution		0010013297	EUR 1.611,00
ULTRA-TURRAX® Tube Drive P control	Disperser	0025005981	
DIS-300-S-M.10	Dissolver tube, 300 ml, 10 pcs.	0020016318	
UTTD control Life Science Solution		0010013296	EUR 1.626,00
ULTRA-TURRAX® Tube Drive P control	Disperser	0025005981	
DT-20	Dispersing tube, 20 ml, 20 pcs.	0003703000	



Tube Mill control Agriculture Solution



C 7000 basic equipment set 2

Product	Description	Ident. No.	Price
SINGLE-USE CRUSHING / IVD PACKAGES			
Tube Mill control Agriculture Solution		0010013298	EUR 2.303,00
Tube Mill control	Batch mill	0004180000	
MT 40.10	Disposable grinding chamber, 40 ml, 10 pcs.	0004425000	
Tube Mill 100 control Pharma Solution		0010013309	EUR 2.498,00
Tube Mill 100 control	Batch mill	0020007144	
MT 100.10	Disposable grinding chamber, 100 ml, 10 pcs.	0020008386	
DOUBLE DRY CALORIMETER			
C 7000 basic equipment set 1		0008800900	Price on request
C 7000	Measurement cell		
C 7010	Decomposition vessel, standard	0003015000	
C 7002	Cooling system	0007011000	
C 48	Oxygen station	0001560000	
C 7000 basic equipment set 2		0008800900	Price on request
C 7000	Measurement cell		
C 7012	Decomposition vessel, halogen resistant	0003017000	
C 7002	Cooling system	0007011000	
C 48	Oxygen station	0001560000	



C 1

Product	Description	Ident. No.	Price
CALORIMETER PACKAGES			
C 1 Package 1/10 Package			
C 1	Calorimeter	0010005633	On request
C 1.10	Combustion chamber	0020010860	
C 1.10	Combustion chamber	0004500300	
RC 2 basic	Recirculating chiller	0004171000	
C 1 Package 2/10 Package			
C 1	Calorimeter	0010005634	On request
C 1	Calorimeter	0020010860	
C 1.10	Combustion chamber	0004500300	
C 1 Package 3/10 Package			
C 1	Calorimeter	0010005635	On request
C 1	Calorimeter	0020010860	
C 1.10	Combustion chamber	0004500300	
C 1.20	Water heater	0004501000	
C 1 Package 1/12 Package			
C 1	Calorimeter	0010005636	On request
C 1	Calorimeter	0020010860	
C 1.12	Combustion chamber, halogen resistant	0004500400	
RC 2 basic	Recirculating chiller	0004171000	
C 1 Package 2/12 Package			
C 1	Calorimeter	0010005637	On request
C 1	Calorimeter	0020010860	
C 1.12	Combustion chamber, halogen resistant	0004500400	
C 1 Package 3/12 Package			
C 1	Calorimeter	0010005638	On request
C 1	Calorimeter	0020010860	
C 1.12	Combustion chamber, halogen resistant	0004500400	
C 1.20	Water heater	0004501000	
C 200 auto Package			
C 200	Measurement cell	0010002379	On request
C 200	Measurement cell	0003385000	
RC 2 basic	Recirculating chiller	0004171000	
C 200.RC	Set of hoses	00020010835	
C 5010	Decomposition vessel	0007114000	
C 248	Oxygen filling station	0003520000	
C 200 h auto Package			
C 200	Measurement cell	0010002387	On request
C 200	Measurement cell	0003385000	
RC 2 basic	Recirculating chiller	0004171000	
C 200.RC	Set of hoses	00020010835	
C 5012	Decomposition vessel, halogen resistant	0007215000	
C 200.2	Conversion kit	0004028800	
C 248	Oxygen filling station	0003520000	



C 200 auto



C 6000

Product	Description	Ident. No.	Price
CALORIMETER PACKAGES			
C 6000 global standards Package 1/10			
C 6000 global standards	Measurement cell	0010004520	On request
C 6000 global standards	Measurement cell	0020005930	
C 6010	Decomposition vessel, standard	0003770000	
RC 2 basic	Recirculating chiller	0004171000	
C 6000 global standards Package 1/12			
C 6000 global standards	Measurement cell	0010004521	On request
C 6000 global standards	Measurement cell	0020005930	
C 6012	Decomposition vessel, halogen resistant	0004504000	
RC 2 basic	Recirculating chiller	0004171000	
C 6000 global standards Package 2/10			
C 6000 global standards	Measurement cell	0010004522	On request
C 6000 global standards	Measurement cell	0020005930	
C 6010	Decomposition vessel, standard	0003770000	
C 6000 global standards Package 2/12			
C 6000 global standards	Measurement cell	0010004523	On request
C 6000 global standards	Measurement cell	0020005930	
C 6012	Decomposition vessel, halogen resistant	0004504000	
C 6000 isoperibol Package 1/10			
C 6000 isoperibol	Measurement cell	0010004524	On request
C 6000 isoperibol	Measurement cell	0020005940	
C 6010	Decomposition vessel, standard	0003770000	
RC 2 basic	Recirculating chiller	0004171000	
C 6000 isoperibol Package 1/12			
C 6000 isoperibol	Measurement cell	0010004525	On request
C 6000 isoperibol	Measurement cell	0020005940	
C 6012	Decomposition vessel, halogen resistant	0004504000	
RC 2 basic	Recirculating chiller	0004171000	
C 6000 isoperibol Package 2/10			
C 6000 isoperibol	Measurement cell	0010004526	On request
C 6000 isoperibol	Measurement cell	0020005940	
C 6010	Decomposition vessel, standard	0003770000	
C 6000 isoperibol Package 2/12			
C 6000 isoperibol	Measurement cell	0010004527	On request
C 6000 isoperibol	Measurement cell	0004025000	
C 6012	Decomposition vessel, halogen resistant	0004504000	



RV 3 V-C



RV 8 V-C

Product	Description	Ident. No.	Price
ROTARY EVAPORATOR PACKAGES*			
RV 3 V Package			
RV 3	Drive	0020015793	
HB eco	Heating bath	0020016337	
RV 10.1	Set of glassware, vertical	0003655300	
RV 10.70	Vapor tube, NS 29/32	0003812200	
RV 3 V-C Package			
RV 3	Drive	0020015793	EUR 2.829,00
HB eco	Heating bath	0020016337	
RV 10.10	Set of glassware, vertical, coated	0003755400	
RV 10.70	Vapor tube, NS 29/32	0003812200	
RV 3 FLEX Package			
RV 3	Drive	0020015793	EUR 2.653,00
HB eco	Heating bath	0020016337	
RV 05.10	Balljoint clamp	0000736600	
RV 10.70	Vapor tube, NS 29/32	0003812200	
RV 10.88	Clamp, NS 29	0003683300	
RV 8 V Package			
RV 8	Drive	0025002822	EUR 3.523,00
HB digital	Heating bath	0020016334	
RV 10.1	Set of glassware, vertical	0003655300	
RV 10.70	Vapor tube, NS 29/32	0003812200	
RV 8 V-C Package			
RV 8	Drive	0025002822	EUR 3.721,00
HB digital	Heating bath	0020016334	
RV 10.10	Set of glassware, vertical, coated	0003755400	
RV 10.70	Vapor tube, NS 29/32	0003812200	
RV 8 FLEX Package			
RV 8	Drive	0025002822	EUR 3.335,00
HB digital	Heating bath	0020016334	
RV 05.10	Balljoint clamp	0000736600	
RV 10.70	Vapor tube, NS 29/32	0003812200	
RV 10.88	Clamp, NS 29	0003683300	



RV 8 Dry Ice Condenser



RV 10 digital Dry Ice Condenser, coated

Product	Description	Ident. No.	Price
ROTARY EVAPORATOR PACKAGES*			
RV 3 dry ice condenser			
RV 3	Drive	0020015793	
HB eco	Heating bath	0020016337	
RV 10.84	Evaporation flask (NS 29/32, 1000 ml)	0003740500	
RV 10.4	Dry ice condenser	0003742000	
RV 10.102	Receiving flask (KS 35/20, 500 ml)	0003742400	
RV 3 dry ice condenser, coated			
RV 3	Drive	0020015793	EUR 3.410,00
HB eco	Heating bath	0020016337	
RV 10.40	Dry ice condenser, coated	0003742100	
RV 10.203	Receiving flask, coated (KS 35/20, 1000 ml)	0003743500	
RV 10.84	Evaporation flask	0003740500	
RV 8 dry ice condenser			
RV 8	Drive	0025002822	EUR 4.105,00
HB digital	Heating bath	0020016334	
RV 10.84	Evaporation flask (NS 29/32, 1000 ml)	0003740500	
RV 10.4	Dry ice condenser	0003742000	
RV 10.102	Receiving flask (KS 35/20, 500 ml)	0003742400	
RV 8 dry ice condenser, coated			
RV 8	Drive	0025002822	EUR 4.302,00
HB digital	Heating bath	0020016334	
RV 10.40	Dry ice condenser, coated	0003742100	
RV 10.203	Receiving flask, coated (KS 35/20, 1000 ml)	0003743500	
RV 10.84	Evaporation flask (NS 29/32, 1000 ml)	0003740500	
RV 10 digital Dry Ice Condenser			
RV 10 digital	Drive	0003550099	EUR 5.895,00
HB digital	Heating bath	0020016334	
RV 10.84	Evaporation flask (NS 29/32, 1000 ml)	0003740500	
RV 10.4	Dry ice condenser	0003742000	
RV 10.102	Receiving flask (KS 35/20, 500 ml)	0003742400	
RV 10 digital dry ice condenser, coated			
RV 10 digital	Drive	0020015793	EUR 6.339,00
HB digital	Heating bath	0020016334	
RV 10.40	Dry ice condenser, coated	0003742100	
RV 10.203	Receiving flask, coated (KS 35/20, 1000 ml)	0003743500	
RV 10.84	Evaporation flask	0003740500	

*Balljoint clamp, clamp NS 29 and vapor tube NS 29/32 included in dry ice packages



RV 10 digital V-C



RV 10 auto pro V-C

Product	Description	Ident. No.	Price
ROTARY EVAPORATOR PACKAGES			
RV 10 digital V Package			
RV 10 digital	Drive	0003550099	
HB digital	Heating bath	0020016334	
RV 10.1	Set of glassware, vertical	0003655300	
RV 10.70	Vapor tube, NS 29/32	0003812200	
RV 10 digital V-C Package			
RV 10 digital	Drive	0003550099	EUR 5.759,00
HB digital	Heating bath	0020016334	
RV 10.10	Set of glassware, vertical, coated	0003755400	
RV 10.70	Vapor tube, NS 29/32	0003812200	
RV 10 digital FLEX Package			
RV 10 digital	Drive	0003550099	EUR 5.100,00
HB digital	Heating bath	0020016334	
RV 05.10	Balljoint clamp	0000736600	
RV 10.70	Vapor tube, NS 29/32	0003812200	
RV 10.88	Clamp, NS 29	0003683300	
RV 10 auto pro V Package			
RV 10 auto	Drive	0020003919	EUR 11.145,00
VACSTAR digital	Pump with analog connection	0020016236	
HB digital	Heating bath	0020016334	
RV 10.1	Set of glassware, vertical	0003655300	
RV 10.70	Vapor tube, NS 29/32	0003812200	
RV 10 auto pro V-C Package			
RV 10 auto	Drive	0020003919	EUR 11.566,00
VACSTAR digital	Pump with analog connection	0020016236	
HB digital	Heating bath	0020016334	
RV 10.10	Set of glassware, vertical, coated	0003755400	
RV 10.70	Vapor tube, NS 29/32	0003812200	
RV 10 auto pro FLEX Package			
RV 10 auto	Drive	0020003919	EUR 11.037,00
VACSTAR digital	Pump with analog connection	0020016236	
HB digital	Heating bath	0020016334	
RV 05.10	Balljoint clamp	0000736600	
RV 10.70	Vapor tube, NS 29/32	0003812200	
RV 10.88	Clamp, NS 29	0003683300	



RV 3 pro V Complete



RV 8 pro V Complete



RV 10 auto pro V-C Complete

Product	Description	Ident. No.	Price
ROTARY EVAPORATOR COMPLETE PACKAGES			
RV 3 pro V Complete			
RV 3 V	Drive	0010011410	EUR 8.293,00
VC 10 lite	Vacuum controller	0020111998	
VACSTAR digital	Pump with analog connection	0020016236	
RC 2 lite	Recirculating chiller	0025006624	
RV 10.5005	Hose kit	0020000552	
VC 10.500	Stand pole	0035002702	
RV 8 pro V Complete			
RV 8 V	Drive	0010011411	EUR 9.980,00
VC 10 lite	Vacuum controller	0020111998	
VACSTAR digital	Pump with analog connection	0020016236	
RC 2 lite	Recirculating chiller	0025006624	
RV 10.5005	Hose kit	0020000552	
RV 8.3	Stand pole	0025004707	
RV 10 digital pro V Complete			
RV 10 digital	Drive	0010011963	EUR 11.031,00
VC 10 lite	Vacuum controller	0020111998	
VACSTAR digital	Pump with analog connection	0020016236	
RC 2 lite	Recirculating chiller	0025006624	
RV 10.5005	Hose kit	0020000552	
VC 10.400	Stand	0035001735	
RV 10 auto pro V-C Complete			
RV 10 auto pro V-C	Drive	0010007353	EUR 12.806,00
VC 10 lite	Vacuum controller	0020111998	
VACSTAR digital	Pump with analog connection	0020016236	
VSE 1	Vacuum safety emission condenser	0035001873	
RC 2 lite	Recirculating chiller	0025006624	
H.SI.8	Hose set	0004569000	
RV 10.70	Vapor tube, NS 29/32	0003812200	
RV 10.10	Set of glassware, vertical, coated	0001091500	
RV 10 digital pro V double Complete			
RV 10 digital pro V (2 pcs.)	Drive	0010011964	EUR 19.612,00
VC 10 pro (2 pcs.)	Vacuum controller	0020111998	
VACSTAR digital	Pump with analog connection	0020016236	
VSE 1	Vacuum safety emission condenser	0035001873	
RC 2 GREEN basic	Recirculating chiller	0025004186	
RV 10.5005 (2 pcs.)	Hose kit	0020000552	
VC 10.300 (2 pcs.)	Check valve	0020011105	
Y hose connector (2 pcs.)	Y-hose connector	0020010963	



EasySyn 500 Starter Reactor system



EasySyn 2000 Starter Reactor system

Product	Description	Ident. No.	Price
SYNTHESIS REACTORS			
EasySyn 500 Starter Reactor system		0020113433	EUR 7.426,00
EUROSTAR 60 digital	Overhead stirrer	0004446000	
R 60	Keyless chuck	0003889500	
SY stand	Stand	0020103316	
SY 500 D Reactor vessel	Double-walled reactor vessel with bottom discharge, 500 ml volume	0020113460	
SY clamp 100	Vessel clamp	0020105944	
SY clamp ring 100	Clamp ring	0020113866	
SY O-ring 100	FEP-coated O-Ring	0020113867	
SY 100.1	Reactor lid	0020113649	
R 4011 SY	Propeller stirrer	0020114111	
SY guide	Stirrer guide	0020109139	
EasySyn 1000 Starter Reactor system		0020113435	EUR 7.534,00
Same content as EasySyn 500 Starter, except:			
SY 1000 D Reactor vessel	Double-walled reactor vessel with bottom discharge, 1000 ml volume	0020113462	
EasySyn 2000 Starter Reactor system		0020113438	EUR 8.369,00
Same content as EasySyn 500 Starter, except:			
SY 2000 D Reactor vessel	Double-walled reactor vessel with bottom discharge, 2000 ml volume	0020113464	
SY clamp 150	Vessel clamp	0020105879	
SY clamp ring 150	Clamp ring	0020113868	
SY O-ring 150	FEP-coated O-Ring	0020113869	
SY 150.1	Reactor lid	0020113660	
R 4012 SY	Propeller stirrer	0020114112	
EasySyn 5000 Starter Reactor system		0020113442	EUR 8.710,00
Same content as EasySyn 500 Starter, except:			
SY 5000 D Reactor vessel	Double-walled reactor vessel with bottom discharge, 5000 ml volume	0020113466	
R 4013 SY	Propeller stirrer	0020114113	



EasySyn 1000 Advanced Reactor system



EasySyn 5000 Advanced Reactor system

Product	Description	Ident. No.	Price
SYNTHESIS REACTORS			
EasySyn 500 Advanced Reactor system		0020113434	EUR 10.144,00
EUROSTAR 100 control	Overhead stirrer	0004446000	
R 60	Keyless chuck	0003889500	
SY stand	Stand	0020103316	
SY 500 D Reactor vessel	Double-walled reactor vessel with bottom discharge, 500 ml volume	0020113460	
LT 5.40	Draining set	0020113266	
SY clamp 100	Vessel clamp	0020105944	
SY clamp ring 100	Clamp ring	0020113866	
SY O-ring 100	FEP-coated O-Ring	0020113867	
SY 100.1	Reactor lid	0020113649	
R 4011 SY	Propeller stirrer	0020114111	
SY guide	Stirrer guide	0020109139	
EasySyn 1000 Advanced Reactor system		0020113436	EUR 10.252,00
Same content as EasySyn 500 Advanced, except:			
SY 1000 D Reactor vessel	Double-walled reactor vessel with bottom discharge, 1000 ml volume	0020113462	
EasySyn 2000 Advanced Reactor system		0020113440	EUR 11.087,00
Same content as EasySyn 500 Advanced, except:			
SY 2000 D Reactor vessel	Double-walled reactor vessel with bottom discharge, 2000 ml volume	0020113464	
SY clamp 150	Vessel clamp	0020105879	
SY clamp ring 150	Clamp ring	0020113868	
SY O-ring 150	FEP-coated O-Ring	0020113869	
SY 150.1	Reactor lid	0020113660	
R 4012 SY	Propeller stirrer	0020114112	
EasySyn 5000 Advanced Reactor system		0020113443	EUR 11.428,00
Same content as EasySyn 500 Advanced, except:			
SY 5000 D Reactor vessel	Double-walled reactor vessel with bottom discharge, 5000 ml volume	0020113466	
R 4013 SY	Propeller stirrer	0020114113	



IKA WORLDWIDE

/// Together to work perfectly

IKA develops and manufactures the most modern solutions for laboratories and for the process industry. In order to make our customers' work even more successful, we combine the latest technology with innovative design and we look far into the future. Our products are prepared accordingly for integration in your digital laboratory.

We are a responsibility-aware family company, whilst also being a global player. Over 900 employees make a contribution each and every day to extending our world-leading market position in laboratory, analytical and processing technology.

In our headquarters in Staufen, we have been developing our products and technologies with the collaboration of application experts from the fields of science and industry for over 70 years. From there, they are sold to more than 160 countries. For excellent local service, IKA also operates its own subsidiaries at sixteen locations on five continents.

● NORTH AMERICA

USA

IKA Works, Inc.
Willmington
 Phone: +1 910 452-7059
sales@ika.net

● SOUTH AMERICA

BRASIL

IKA Brasil
Campinas/Rio de Janero
 Phone: +55 19 3772-9600
sales@ika.net.br

● EUROPE

GERMANY

IKA-Werke GmbH & Co. KG
Staufen
 Phone: +49 7633 831-0
sales@ika.de

UNITED KINGDOM

IKA England LTD.
Oxford
 Phone: +44 1865 986 162
sales.England@ika.com

POLAND

IKA Poland Sp. z o.o.
Warsaw
 Phone: +48 22 201 99 79
sales.poland@ika.com

TURKEY

IKA Turkey
Istanbul (Tuzla)
 Phone: +90 216 394 43 43
sales.turkey@ika.com

SPAIN

IKA Works Spain, S. L.
Barcelona
sales.spain@ika.com

● AFRICA

KENYA

IKA Works Kenya Ltd.
Nairobi
 Phone: +254 112 323 745
sales.kenya@ika.com

UGANDA

IKA Works Kampala Limited
Kampala
 Phone: +254 112 323 745
sales.uganda@ika.com

● ASIA

INDIA

IKA India Private Limited
Bangalore
 Phone: +91 80 26253 900
info@ika.in

THAILAND

IKA Works (Thailand) Co. Ltd.
Bangkok
 Phone: +66 2059 4690
sales.lab-thailand@ika.com

MALAYSIA

IKA Works (Asia) Sdn Bhd
Kuala Lumpur (Rawang)
 Phone: +60 3 6099-5666
sales.lab@ika.my

VIETNAM

IKA Vietnam Company Limited
Ho Chi Minh City
 Phone: +84 28 38202142
sales.lab-vietnam@ika.com

CHINA

IKA Works Guangzhou
Guangzhou
 Phone: +86 20 8222 6771
info@ika.cn

KOREA

IKA Korea Ltd.
Seoul
 Phone: +82 2 2136 6800
info@ika.kr

JAPAN

IKA Japan K.K.
Osaka
 Phone: +81 6 6730 6781
info_japan@ika.ne.jp



designed for scientists

Everything for your Lab

IKA is your reliable partner in laboratory, analysis and process technology. When it comes to applications in the areas of stirring, mixing, tempering, distilling or grinding, market leaders rely on our proven products and technology. We are continually working to further develop our portfolio according to the needs of our customers. Building on this, we network our products and services to create holistic, application-oriented solutions and enable our customers to achieve the best possible results and step into the digital age.



BIOREACTORS



MIXING



HEATING / COOLING /
TEMPERING



LIQUID HANDLING



MEASURING VISCOSITY



VACUUM TECHNOLOGY



CRUSHING



LABORATORY SOFTWARE



SEPARATION



ELECTROCHEMISTRY
FLOW CHEMISTRY



REACTOR SYSTEMS



CALORIMETRY

IKA-Werke GmbH & Co. KG
Janke & Kunkel-Straße 10,
79219 Staufen, Germany
+49 7633 831-0 / sales@ika.de



IKAworlwide // #lookattheblue



Stay up to date:
[www.ika.com/
newsletter](http://www.ika.com/newsletter)

Prices are valid until October 31, 2024.
All prices plus VAT. Prices and technical
specifications are subject to change
without notice.
Information on delivery not binding